

Internet Engineering Task Force (IETF)  
Request for Comments: 5245  
Obsoletes: 4091, 4092  
Category: Standards Track  
ISSN: 2070-1721

J. Rosenberg  
jdrosen.net  
April 2010

Interactive Connectivity Establishment (ICE):  
A Protocol for Network Address Translator (NAT) Traversal for  
Offer/Answer Protocols

Abstract

This document describes a protocol for Network Address Translator (NAT) traversal for UDP-based multimedia sessions established with the offer/answer model. This protocol is called Interactive Connectivity Establishment (ICE). ICE makes use of the Session Traversal Utilities for NAT (STUN) protocol and its extension, Traversal Using Relay NAT (TURN). ICE can be used by any protocol utilizing the offer/answer model, such as the Session Initiation Protocol (SIP).

Status of This Memo

This is an Internet Standards Track document.

This document is a product of the Internet Engineering Task Force (IETF). It represents the consensus of the IETF community. It has received public review and has been approved for publication by the Internet Engineering Steering Group (IESG). Further information on Internet Standards is available in Section 2 of RFC 5741.

Information about the current status of this document, any errata, and how to provide feedback on it may be obtained at <http://www.rfc-editor.org/info/rfc5245>.

## Copyright Notice

Copyright (c) 2010 IETF Trust and the persons identified as the document authors. All rights reserved.

This document is subject to BCP 78 and the IETF Trust's Legal Provisions Relating to IETF Documents (<http://trustee.ietf.org/license-info>) in effect on the date of publication of this document. Please review these documents carefully, as they describe your rights and restrictions with respect to this document. Code Components extracted from this document must include Simplified BSD License text as described in Section 4.e of the Trust Legal Provisions and are provided without warranty as described in the Simplified BSD License.

## Table of Contents

1.	Introduction . . . . .	6
2.	Overview of ICE . . . . .	7
2.1.	Gathering Candidate Addresses . . . . .	9
2.2.	Connectivity Checks . . . . .	11
2.3.	Sorting Candidates . . . . .	12
2.4.	Frozen Candidates . . . . .	13
2.5.	Security for Checks . . . . .	14
2.6.	Concluding ICE . . . . .	14
2.7.	Lite Implementations . . . . .	16
3.	Terminology . . . . .	16
4.	Sending the Initial Offer . . . . .	19
4.1.	Full Implementation Requirements . . . . .	19
4.1.1.	Gathering Candidates . . . . .	19
4.1.1.1.	Host Candidates . . . . .	20
4.1.1.2.	Server Reflexive and Relayed Candidates . . . . .	20
4.1.1.3.	Computing Foundations . . . . .	22
4.1.1.4.	Keeping Candidates Alive . . . . .	22
4.1.2.	Prioritizing Candidates . . . . .	22
4.1.2.1.	Recommended Formula . . . . .	23
4.1.2.2.	Guidelines for Choosing Type and Local Preferences . . . . .	23
4.1.3.	Eliminating Redundant Candidates . . . . .	25
4.1.4.	Choosing Default Candidates . . . . .	25
4.2.	Lite Implementation Requirements . . . . .	25
4.3.	Encoding the SDP . . . . .	26
5.	Receiving the Initial Offer . . . . .	28
5.1.	Verifying ICE Support . . . . .	28
5.2.	Determining Role . . . . .	29
5.3.	Gathering Candidates . . . . .	30
5.4.	Prioritizing Candidates . . . . .	30
5.5.	Choosing Default Candidates . . . . .	31

5.6.	Encoding the SDP . . . . .	31
5.7.	Forming the Check Lists . . . . .	31
5.7.1.	Forming Candidate Pairs . . . . .	31
5.7.2.	Computing Pair Priority and Ordering Pairs . . . . .	34
5.7.3.	Pruning the Pairs . . . . .	34
5.7.4.	Computing States . . . . .	34
5.8.	Scheduling Checks . . . . .	37
6.	Receipt of the Initial Answer . . . . .	39
6.1.	Verifying ICE Support . . . . .	39
6.2.	Determining Role . . . . .	39
6.3.	Forming the Check List . . . . .	40
6.4.	Performing Ordinary Checks . . . . .	40
7.	Performing Connectivity Checks . . . . .	40
7.1.	STUN Client Procedures . . . . .	40
7.1.1.	Creating Permissions for Relayed Candidates . . . . .	40
7.1.2.	Sending the Request . . . . .	40
7.1.2.1.	PRIORITY and USE-CANDIDATE . . . . .	41
7.1.2.2.	ICE-CONTROLLED and ICE-CONTROLLING . . . . .	41
7.1.2.3.	Forming Credentials . . . . .	41
7.1.2.4.	DiffServ Treatment . . . . .	42
7.1.3.	Processing the Response . . . . .	42
7.1.3.1.	Failure Cases . . . . .	42
7.1.3.2.	Success Cases . . . . .	43
7.1.3.2.1.	Discovering Peer Reflexive Candidates . . . . .	43
7.1.3.2.2.	Constructing a Valid Pair . . . . .	44
7.1.3.2.3.	Updating Pair States . . . . .	45
7.1.3.2.4.	Updating the Nominated Flag . . . . .	46
7.1.3.3.	Check List and Timer State Updates . . . . .	46
7.2.	STUN Server Procedures . . . . .	46
7.2.1.	Additional Procedures for Full Implementations . . . . .	47
7.2.1.1.	Detecting and Repairing Role Conflicts . . . . .	47
7.2.1.2.	Computing Mapped Address . . . . .	48
7.2.1.3.	Learning Peer Reflexive Candidates . . . . .	49
7.2.1.4.	Triggered Checks . . . . .	49
7.2.1.5.	Updating the Nominated Flag . . . . .	50
7.2.2.	Additional Procedures for Lite Implementations . . . . .	51
8.	Concluding ICE Processing . . . . .	51
8.1.	Procedures for Full Implementations . . . . .	51
8.1.1.	Nominating Pairs . . . . .	51
8.1.1.1.	Regular Nomination . . . . .	52
8.1.1.2.	Aggressive Nomination . . . . .	52
8.1.2.	Updating States . . . . .	53
8.2.	Procedures for Lite Implementations . . . . .	54
8.2.1.	Peer Is Full . . . . .	54
8.2.2.	Peer Is Lite . . . . .	55
8.3.	Freeing Candidates . . . . .	56
8.3.1.	Full Implementation Procedures . . . . .	56
8.3.2.	Lite Implementation Procedures . . . . .	56

9.	Subsequent Offer/Answer Exchanges . . . . .	56
9.1.	Generating the Offer . . . . .	57
9.1.1.	Procedures for All Implementations . . . . .	57
9.1.1.1.	ICE Restarts . . . . .	57
9.1.1.2.	Removing a Media Stream . . . . .	58
9.1.1.3.	Adding a Media Stream . . . . .	58
9.1.2.	Procedures for Full Implementations . . . . .	58
9.1.2.1.	Existing Media Streams with ICE Running . . . . .	58
9.1.2.2.	Existing Media Streams with ICE Completed . . . . .	59
9.1.3.	Procedures for Lite Implementations . . . . .	59
9.1.3.1.	Existing Media Streams with ICE Running . . . . .	59
9.1.3.2.	Existing Media Streams with ICE Completed . . . . .	60
9.2.	Receiving the Offer and Generating an Answer . . . . .	60
9.2.1.	Procedures for All Implementations . . . . .	60
9.2.1.1.	Detecting ICE Restart . . . . .	60
9.2.1.2.	New Media Stream . . . . .	61
9.2.1.3.	Removed Media Stream . . . . .	61
9.2.2.	Procedures for Full Implementations . . . . .	61
9.2.2.1.	Existing Media Streams with ICE Running and no remote-candidates . . . . .	61
9.2.2.2.	Existing Media Streams with ICE Completed and no remote-candidates . . . . .	61
9.2.2.3.	Existing Media Streams and remote-candidates . . . . .	61
9.2.3.	Procedures for Lite Implementations . . . . .	62
9.3.	Updating the Check and Valid Lists . . . . .	63
9.3.1.	Procedures for Full Implementations . . . . .	63
9.3.1.1.	ICE Restarts . . . . .	63
9.3.1.2.	New Media Stream . . . . .	63
9.3.1.3.	Removed Media Stream . . . . .	64
9.3.1.4.	ICE Continuing for Existing Media Stream . . . . .	64
9.3.2.	Procedures for Lite Implementations . . . . .	64
10.	Keepalives . . . . .	65
11.	Media Handling . . . . .	66
11.1.	Sending Media . . . . .	66
11.1.1.	Procedures for Full Implementations . . . . .	66
11.1.2.	Procedures for Lite Implementations . . . . .	67
11.1.3.	Procedures for All Implementations . . . . .	67
11.2.	Receiving Media . . . . .	67
12.	Usage with SIP . . . . .	68
12.1.	Latency Guidelines . . . . .	68
12.1.1.	Offer in INVITE . . . . .	68
12.1.2.	Offer in Response . . . . .	70
12.2.	SIP Option Tags and Media Feature Tags . . . . .	70
12.3.	Interactions with Forking . . . . .	70
12.4.	Interactions with Preconditions . . . . .	70
12.5.	Interactions with Third Party Call Control . . . . .	71
13.	Relationship with ANAT . . . . .	71
14.	Extensibility Considerations . . . . .	72

15. Grammar . . . . .	73
15.1. "candidate" Attribute . . . . .	73
15.2. "remote-candidates" Attribute . . . . .	75
15.3. "ice-lite" and "ice-mismatch" Attributes . . . . .	75
15.4. "ice-ufrag" and "ice-pwd" Attributes . . . . .	76
15.5. "ice-options" Attribute . . . . .	76
16. Setting Ta and RTO . . . . .	76
16.1. RTP Media Streams . . . . .	77
16.2. Non-RTP Sessions . . . . .	78
17. Example . . . . .	79
18. Security Considerations . . . . .	85
18.1. Attacks on Connectivity Checks . . . . .	86
18.2. Attacks on Server Reflexive Address Gathering . . . . .	88
18.3. Attacks on Relayed Candidate Gathering . . . . .	89
18.4. Attacks on the Offer/Answer Exchanges . . . . .	89
18.5. Insider Attacks . . . . .	90
18.5.1. The Voice Hammer Attack . . . . .	90
18.5.2. STUN Amplification Attack . . . . .	90
18.6. Interactions with Application Layer Gateways and SIP . . . . .	91
19. STUN Extensions . . . . .	92
19.1. New Attributes . . . . .	92
19.2. New Error Response Codes . . . . .	93
20. Operational Considerations . . . . .	93
20.1. NAT and Firewall Types . . . . .	93
20.2. Bandwidth Requirements . . . . .	93
20.2.1. STUN and TURN Server Capacity Planning . . . . .	93
20.2.2. Gathering and Connectivity Checks . . . . .	94
20.2.3. Keepalives . . . . .	94
20.3. ICE and ICE-lite . . . . .	95
20.4. Troubleshooting and Performance Management . . . . .	95
20.5. Endpoint Configuration . . . . .	95
21. IANA Considerations . . . . .	96
21.1. SDP Attributes . . . . .	96
21.1.1. candidate Attribute . . . . .	96
21.1.2. remote-candidates Attribute . . . . .	96
21.1.3. ice-lite Attribute . . . . .	97
21.1.4. ice-mismatch Attribute . . . . .	97
21.1.5. ice-pwd Attribute . . . . .	98
21.1.6. ice-ufrag Attribute . . . . .	98
21.1.7. ice-options Attribute . . . . .	98
21.2. STUN Attributes . . . . .	99
21.3. STUN Error Responses . . . . .	99
22. IAB Considerations . . . . .	99
22.1. Problem Definition . . . . .	100
22.2. Exit Strategy . . . . .	100
22.3. Brittleness Introduced by ICE . . . . .	101
22.4. Requirements for a Long-Term Solution . . . . .	102
22.5. Issues with Existing NAPT Boxes . . . . .	102

23. Acknowledgements . . . . .	102
24. References . . . . .	103
24.1. Normative References . . . . .	103
24.2. Informative References . . . . .	104
Appendix A. Lite and Full Implementations . . . . .	107
Appendix B. Design Motivations . . . . .	108
B.1. Pacing of STUN Transactions . . . . .	108
B.2. Candidates with Multiple Bases . . . . .	109
B.3. Purpose of the <rel-addr> and <rel-port> Attributes . . . . .	111
B.4. Importance of the STUN Username . . . . .	111
B.5. The Candidate Pair Priority Formula . . . . .	113
B.6. The remote-candidates Attribute . . . . .	113
B.7. Why Are Keepalives Needed? . . . . .	114
B.8. Why Prefer Peer Reflexive Candidates? . . . . .	115
B.9. Why Send an Updated Offer? . . . . .	115
B.10. Why Are Binding Indications Used for Keepalives? . . . . .	115
B.11. Why Is the Conflict Resolution Mechanism Needed? . . . . .	116

## 1. Introduction

RFC 3264 [RFC3264] defines a two-phase exchange of Session Description Protocol (SDP) messages [RFC4566] for the purposes of establishment of multimedia sessions. This offer/answer mechanism is used by protocols such as the Session Initiation Protocol (SIP) [RFC3261].

Protocols using offer/answer are difficult to operate through Network Address Translators (NATs). Because their purpose is to establish a flow of media packets, they tend to carry the IP addresses and ports of media sources and sinks within their messages, which is known to be problematic through NAT [RFC3235]. The protocols also seek to create a media flow directly between participants, so that there is no application layer intermediary between them. This is done to reduce media latency, decrease packet loss, and reduce the operational costs of deploying the application. However, this is difficult to accomplish through NAT. A full treatment of the reasons for this is beyond the scope of this specification.

Numerous solutions have been defined for allowing these protocols to operate through NAT. These include Application Layer Gateways (ALGs), the Middlebox Control Protocol [RFC3303], the original Simple Traversal of UDP Through NAT (STUN) [RFC3489] specification, and Realm Specific IP [RFC3102] [RFC3103] along with session description extensions needed to make them work, such as the Session Description Protocol (SDP) [RFC4566] attribute for the Real Time Control Protocol (RTCP) [RFC3605]. Unfortunately, these techniques all have pros and cons which, make each one optimal in some network topologies, but a poor choice in others. The result is that administrators and

implementors are making assumptions about the topologies of the networks in which their solutions will be deployed. This introduces complexity and brittleness into the system. What is needed is a single solution that is flexible enough to work well in all situations.

This specification defines Interactive Connectivity Establishment (ICE) as a technique for NAT traversal for UDP-based media streams (though ICE can be extended to handle other transport protocols, such as TCP [ICE-TCP]) established by the offer/answer model. ICE is an extension to the offer/answer model, and works by including a multiplicity of IP addresses and ports in SDP offers and answers, which are then tested for connectivity by peer-to-peer connectivity checks. The IP addresses and ports included in the SDP and the connectivity checks are performed using the revised STUN specification [RFC5389], now renamed to Session Traversal Utilities for NAT. The new name and new specification reflect its new role as a tool that is used with other NAT traversal techniques (namely ICE) rather than a standalone NAT traversal solution, as the original STUN specification was. ICE also makes use of Traversal Using Relays around NAT (TURN) [RFC5766], an extension to STUN. Because ICE exchanges a multiplicity of IP addresses and ports for each media stream, it also allows for address selection for multihomed and dual-stack hosts, and for this reason it deprecates RFC 4091 [RFC4091] and [RFC4092].

## 2. Overview of ICE

In a typical ICE deployment, we have two endpoints (known as AGENTS in RFC 3264 terminology) that want to communicate. They are able to communicate indirectly via some signaling protocol (such as SIP), by which they can perform an offer/answer exchange of SDP [RFC3264] messages. Note that ICE is not intended for NAT traversal for SIP, which is assumed to be provided via another mechanism [RFC5626]. At the beginning of the ICE process, the agents are ignorant of their own topologies. In particular, they might or might not be behind a NAT (or multiple tiers of NATs). ICE allows the agents to discover enough information about their topologies to potentially find one or more paths by which they can communicate.

Figure 1 shows a typical environment for ICE deployment. The two endpoints are labelled L and R (for left and right, which helps visualize call flows). Both L and R are behind their own respective NATs though they may not be aware of it. The type of NAT and its properties are also unknown. Agents L and R are capable of engaging in an offer/answer exchange by which they can exchange SDP messages, whose purpose is to set up a media session between L and R. Typically, this exchange will occur through a SIP server.

In addition to the agents, a SIP server and NATs, ICE is typically used in concert with STUN or TURN servers in the network. Each agent can have its own STUN or TURN server, or they can be the same.

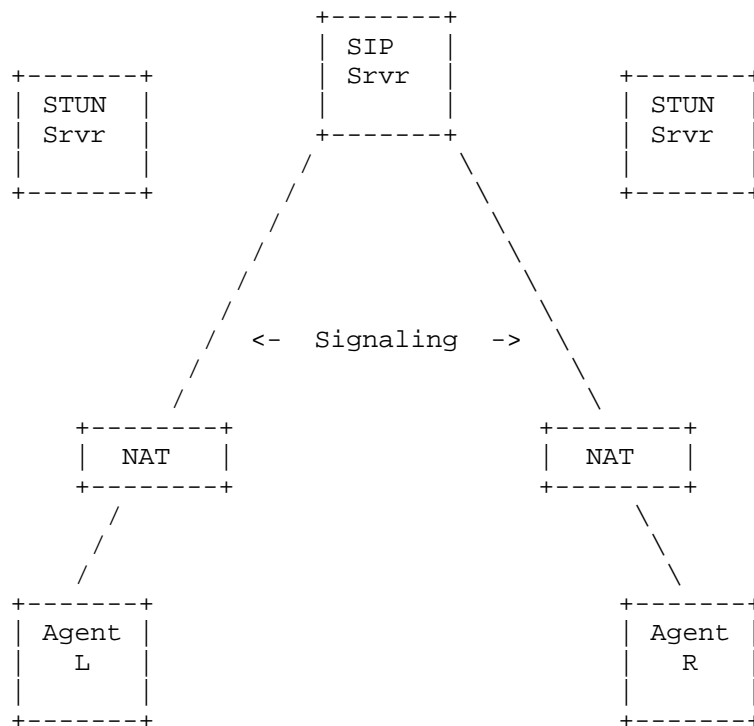

Figure 1: ICE Deployment Scenario

The basic idea behind ICE is as follows: each agent has a variety of candidate TRANSPORT ADDRESSES (combination of IP address and port for a particular transport protocol, which is always UDP in this specification)) it could use to communicate with the other agent. These might include:

- o A transport address on a directly attached network interface
- o A translated transport address on the public side of a NAT (a "server reflexive" address)
- o A transport address allocated from a TURN server (a "relayed address").

Potentially, any of L's candidate transport addresses can be used to communicate with any of R's candidate transport addresses. In



practice, however, many combinations will not work. For instance, if L and R are both behind NATs, their directly attached interface addresses are unlikely to be able to communicate directly (this is why ICE is needed, after all!). The purpose of ICE is to discover which pairs of addresses will work. The way that ICE does this is to systematically try all possible pairs (in a carefully sorted order) until it finds one or more that work.

## 2.1. Gathering Candidate Addresses

In order to execute ICE, an agent has to identify all of its address candidates. A CANDIDATE is a transport address -- a combination of IP address and port for a particular transport protocol (with only UDP specified here). This document defines three types of candidates, some derived from physical or logical network interfaces, others discoverable via STUN and TURN. Naturally, one viable candidate is a transport address obtained directly from a local interface. Such a candidate is called a HOST CANDIDATE. The local interface could be ethernet or WiFi, or it could be one that is obtained through a tunnel mechanism, such as a Virtual Private Network (VPN) or Mobile IP (MIP). In all cases, such a network interface appears to the agent as a local interface from which ports (and thus candidates) can be allocated.

If an agent is multihomed, it obtains a candidate from each IP address. Depending on the location of the PEER (the other agent in the session) on the IP network relative to the agent, the agent may be reachable by the peer through one or more of those IP addresses. Consider, for example, an agent that has a local IP address on a private net 10 network (I1), and a second connected to the public Internet (I2). A candidate from I1 will be directly reachable when communicating with a peer on the same private net 10 network, while a candidate from I2 will be directly reachable when communicating with a peer on the public Internet. Rather than trying to guess which IP address will work prior to sending an offer, the offering agent includes both candidates in its offer.

Next, the agent uses STUN or TURN to obtain additional candidates. These come in two flavors: translated addresses on the public side of a NAT (SERVER REFLEXIVE CANDIDATES) and addresses on TURN servers (RELAYED CANDIDATES). When TURN servers are utilized, both types of candidates are obtained from the TURN server. If only STUN servers are utilized, only server reflexive candidates are obtained from them. The relationship of these candidates to the host candidate is shown in Figure 2. In this figure, both types of candidates are discovered using TURN. In the figure, the notation X:x means IP address X and UDP port x.

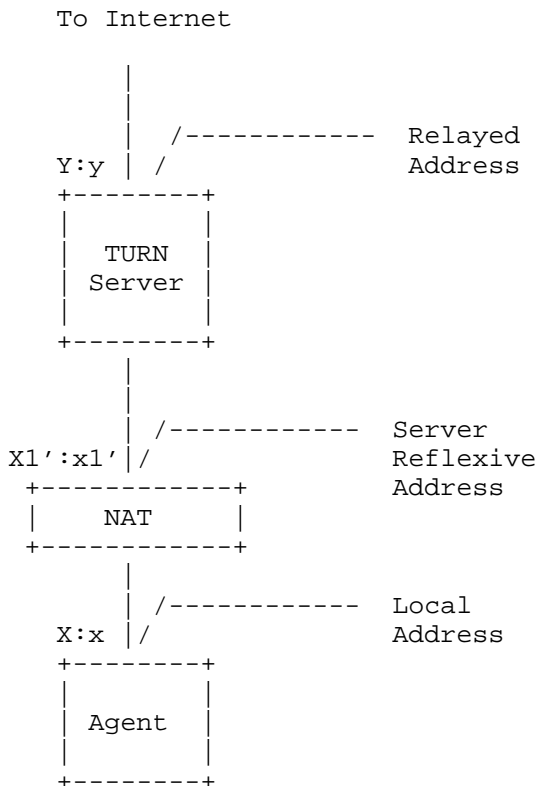

Figure 2: Candidate Relationships

When the agent sends the TURN Allocate request from IP address and port  $X:x$ , the NAT (assuming there is one) will create a binding  $Xl':xl'$ , mapping this server reflexive candidate to the host candidate  $X:x$ . Outgoing packets sent from the host candidate will be translated by the NAT to the server reflexive candidate. Incoming packets sent to the server reflexive candidate will be translated by the NAT to the host candidate and forwarded to the agent. We call the host candidate associated with a given server reflexive candidate the BASE.

Note: "Base" refers to the address an agent sends from for a particular candidate. Thus, as a degenerate case host candidates also have a base, but it's the same as the host candidate.

When there are multiple NATs between the agent and the TURN server, the TURN request will create a binding on each NAT, but only the outermost server reflexive candidate (the one nearest the TURN

server) will be discovered by the agent. If the agent is not behind a NAT, then the base candidate will be the same as the server reflexive candidate and the server reflexive candidate is redundant and will be eliminated.

The Allocate request then arrives at the TURN server. The TURN server allocates a port  $y$  from its local IP address  $Y$ , and generates an Allocate response, informing the agent of this relayed candidate. The TURN server also informs the agent of the server reflexive candidate,  $X1':x1'$  by copying the source transport address of the Allocate request into the Allocate response. The TURN server acts as a packet relay, forwarding traffic between  $L$  and  $R$ . In order to send traffic to  $L$ ,  $R$  sends traffic to the TURN server at  $Y:y$ , and the TURN server forwards that to  $X1':x1'$ , which passes through the NAT where it is mapped to  $X:x$  and delivered to  $L$ .

When only STUN servers are utilized, the agent sends a STUN Binding request [RFC5389] to its STUN server. The STUN server will inform the agent of the server reflexive candidate  $X1':x1'$  by copying the source transport address of the Binding request into the Binding response.

## 2.2. Connectivity Checks

Once  $L$  has gathered all of its candidates, it orders them in highest to lowest priority and sends them to  $R$  over the signaling channel. The candidates are carried in attributes in the SDP offer. When  $R$  receives the offer, it performs the same gathering process and responds with its own list of candidates. At the end of this process, each agent has a complete list of both its candidates and its peer's candidates. It pairs them up, resulting in CANDIDATE PAIRS. To see which pairs work, each agent schedules a series of CHECKS. Each check is a STUN request/response transaction that the client will perform on a particular candidate pair by sending a STUN request from the local candidate to the remote candidate.

The basic principle of the connectivity checks is simple:

1. Sort the candidate pairs in priority order.
2. Send checks on each candidate pair in priority order.
3. Acknowledge checks received from the other agent.

With both agents performing a check on a candidate pair, the result is a 4-way handshake:

```

L           R
-           -
STUN request ->          \ L's
                    <- STUN response / check

                    <- STUN request \ R's
STUN response ->          / check

```

Figure 3: Basic Connectivity Check

It is important to note that the STUN requests are sent to and from the exact same IP addresses and ports that will be used for media (e.g., RTP and RTCP). Consequently, agents demultiplex STUN and RTP/RTCP using contents of the packets, rather than the port on which they are received. Fortunately, this demultiplexing is easy to do, especially for RTP and RTCP.

Because a STUN Binding request is used for the connectivity check, the STUN Binding response will contain the agent's translated transport address on the public side of any NATs between the agent and its peer. If this transport address is different from other candidates the agent already learned, it represents a new candidate, called a PEER REFLEXIVE CANDIDATE, which then gets tested by ICE just the same as any other candidate.

As an optimization, as soon as R gets L's check message, R schedules a connectivity check message to be sent to L on the same candidate pair. This accelerates the process of finding a valid candidate, and is called a TRIGGERED CHECK.

At the end of this handshake, both L and R know that they can send (and receive) messages end-to-end in both directions.

### 2.3. Sorting Candidates

Because the algorithm above searches all candidate pairs, if a working pair exists it will eventually find it no matter what order the candidates are tried in. In order to produce faster (and better) results, the candidates are sorted in a specified order. The resulting list of sorted candidate pairs is called the CHECK LIST. The algorithm is described in Section 4.1.2 but follows two general principles:

- o Each agent gives its candidates a numeric priority, which is sent along with the candidate to the peer.

- o The local and remote priorities are combined so that each agent has the same ordering for the candidate pairs.

The second property is important for getting ICE to work when there are NATs in front of L and R. Frequently, NATs will not allow packets in from a host until the agent behind the NAT has sent a packet towards that host. Consequently, ICE checks in each direction will not succeed until both sides have sent a check through their respective NATs.

The agent works through this check list by sending a STUN request for the next candidate pair on the list periodically. These are called ORDINARY CHECKS.

In general, the priority algorithm is designed so that candidates of similar type get similar priorities and so that more direct routes (that is, through fewer media relays and through fewer NATs) are preferred over indirect ones (ones with more media relays and more NATs). Within those guidelines, however, agents have a fair amount of discretion about how to tune their algorithms.

#### 2.4. Frozen Candidates

The previous description only addresses the case where the agents wish to establish a media session with one COMPONENT (a piece of a media stream requiring a single transport address; a media stream may require multiple components, each of which has to work for the media stream as a whole to be work). Typically (e.g., with RTP and RTCP), the agents actually need to establish connectivity for more than one flow.

The network properties are likely to be very similar for each component (especially because RTP and RTCP are sent and received from the same IP address). It is usually possible to leverage information from one media component in order to determine the best candidates for another. ICE does this with a mechanism called "frozen candidates".

Each candidate is associated with a property called its FOUNDATION. Two candidates have the same foundation when they are "similar" -- of the same type and obtained from the same host candidate and STUN server using the same protocol. Otherwise, their foundation is different. A candidate pair has a foundation too, which is just the concatenation of the foundations of its two candidates. Initially, only the candidate pairs with unique foundations are tested. The other candidate pairs are marked "frozen". When the connectivity checks for a candidate pair succeed, the other candidate pairs with

the same foundation are unfrozen. This avoids repeated checking of components that are superficially more attractive but in fact are likely to fail.

While we've described "frozen" here as a separate mechanism for expository purposes, in fact it is an integral part of ICE and the ICE prioritization algorithm automatically ensures that the right candidates are unfrozen and checked in the right order.

## 2.5. Security for Checks

Because ICE is used to discover which addresses can be used to send media between two agents, it is important to ensure that the process cannot be hijacked to send media to the wrong location. Each STUN connectivity check is covered by a message authentication code (MAC) computed using a key exchanged in the signaling channel. This MAC provides message integrity and data origin authentication, thus stopping an attacker from forging or modifying connectivity check messages. Furthermore, if the SIP [RFC3261] caller is using ICE, and their call forks, the ICE exchanges happen independently with each forked recipient. In such a case, the keys exchanged in the signaling help associate each ICE exchange with each forked recipient.

## 2.6. Concluding ICE

ICE checks are performed in a specific sequence, so that high-priority candidate pairs are checked first, followed by lower-priority ones. One way to conclude ICE is to declare victory as soon as a check for each component of each media stream completes successfully. Indeed, this is a reasonable algorithm, and details for it are provided below. However, it is possible that a packet loss will cause a higher-priority check to take longer to complete. In that case, allowing ICE to run a little longer might produce better results. More fundamentally, however, the prioritization defined by this specification may not yield "optimal" results. As an example, if the aim is to select low-latency media paths, usage of a relay is a hint that latencies may be higher, but it is nothing more than a hint. An actual round-trip time (RTT) measurement could be made, and it might demonstrate that a pair with lower priority is actually better than one with higher priority.

Consequently, ICE assigns one of the agents in the role of the CONTROLLING AGENT, and the other of the CONTROLLED AGENT. The controlling agent gets to nominate which candidate pairs will get used for media amongst the ones that are valid. It can do this in one of two ways -- using REGULAR NOMINATION or AGGRESSIVE NOMINATION.

With regular nomination, the controlling agent lets the checks continue until at least one valid candidate pair for each media stream is found. Then, it picks amongst those that are valid, and sends a second STUN request on its NOMINATED candidate pair, but this time with a flag set to tell the peer that this pair has been nominated for use. This is shown in Figure 4.

```

L                               R
-                               -
STUN request ->                 \ L's
    <- STUN response           /  check

    <- STUN request             \ R's
STUN response ->                /  check

STUN request + flag ->         \ L's
    <- STUN response           /  check

```

Figure 4: Regular Nomination

Once the STUN transaction with the flag completes, both sides cancel any future checks for that media stream. ICE will now send media using this pair. The pair an ICE agent is using for media is called the SELECTED PAIR.

In aggressive nomination, the controlling agent puts the flag in every STUN request it sends. This way, once the first check succeeds, ICE processing is complete for that media stream and the controlling agent doesn't have to send a second STUN request. The selected pair will be the highest-priority valid pair whose check succeeded. Aggressive nomination is faster than regular nomination, but gives less flexibility. Aggressive nomination is shown in Figure 5.

```

L                               R
-                               -
STUN request + flag ->         \ L's
    <- STUN response           /  check

    <- STUN request             \ R's
STUN response ->                /  check

```

Figure 5: Aggressive Nomination

Once all of the media streams are completed, the controlling endpoint sends an updated offer if the candidates in the m and c lines for the media stream (called the DEFAULT CANDIDATES) don't match ICE's SELECTED CANDIDATES.

Once ICE is concluded, it can be restarted at any time for one or all of the media streams by either agent. This is done by sending an updated offer indicating a restart.

### 2.7. Lite Implementations

In order for ICE to be used in a call, both agents need to support it. However, certain agents will always be connected to the public Internet and have a public IP address at which it can receive packets from any correspondent. To make it easier for these devices to support ICE, ICE defines a special type of implementation called LITE (in contrast to the normal FULL implementation). A lite implementation doesn't gather candidates; it includes only host candidates for any media stream. Lite agents do not generate connectivity checks or run the state machines, though they need to be able to respond to connectivity checks. When a lite implementation connects with a full implementation, the full agent takes the role of the controlling agent, and the lite agent takes on the controlled role. When two lite implementations connect, no checks are sent.

For guidance on when a lite implementation is appropriate, see the discussion in Appendix A.

It is important to note that the lite implementation was added to this specification to provide a stepping stone to full implementation. Even for devices that are always connected to the public Internet, a full implementation is preferable if achievable.

### 3. Terminology

The key words "MUST", "MUST NOT", "REQUIRED", "SHALL", "SHALL NOT", "SHOULD", "SHOULD NOT", "RECOMMENDED", "MAY", and "OPTIONAL" in this document are to be interpreted as described in RFC 2119 [RFC2119].

Readers should be familiar with the terminology defined in the offer/answer model [RFC3264], STUN [RFC5389], and NAT Behavioral requirements for UDP [RFC4787].

This specification makes use of the following additional terminology:

Agent: As defined in RFC 3264, an agent is the protocol implementation involved in the offer/answer exchange. There are two agents involved in an offer/answer exchange.



Peer: From the perspective of one of the agents in a session, its peer is the other agent. Specifically, from the perspective of the offerer, the peer is the answerer. From the perspective of the answerer, the peer is the offerer.

Transport Address: The combination of an IP address and transport protocol (such as UDP or TCP) port.

Candidate: A transport address that is a potential point of contact for receipt of media. Candidates also have properties -- their type (server reflexive, relayed or host), priority, foundation, and base.

Component: A component is a piece of a media stream requiring a single transport address; a media stream may require multiple components, each of which has to work for the media stream as a whole to work. For media streams based on RTP, there are two components per media stream -- one for RTP, and one for RTCP.

Host Candidate: A candidate obtained by binding to a specific port from an IP address on the host. This includes IP addresses on physical interfaces and logical ones, such as ones obtained through Virtual Private Networks (VPNs) and Realm Specific IP (RSIP) [RFC3102] (which lives at the operating system level).

Server Reflexive Candidate: A candidate whose IP address and port are a binding allocated by a NAT for an agent when it sent a packet through the NAT to a server. Server reflexive candidates can be learned by STUN servers using the Binding request, or TURN servers, which provides both a relayed and server reflexive candidate.

Peer Reflexive Candidate: A candidate whose IP address and port are a binding allocated by a NAT for an agent when it sent a STUN Binding request through the NAT to its peer.

Relayed Candidate: A candidate obtained by sending a TURN Allocate request from a host candidate to a TURN server. The relayed candidate is resident on the TURN server, and the TURN server relays packets back towards the agent.

Base: The base of a server reflexive candidate is the host candidate from which it was derived. A host candidate is also said to have a base, equal to that candidate itself. Similarly, the base of a relayed candidate is that candidate itself.

**Foundation:** An arbitrary string that is the same for two candidates that have the same type, base IP address, protocol (UDP, TCP, etc.), and STUN or TURN server. If any of these are different, then the foundation will be different. Two candidate pairs with the same foundation pairs are likely to have similar network characteristics. Foundations are used in the frozen algorithm.

**Local Candidate:** A candidate that an agent has obtained and included in an offer or answer it sent.

**Remote Candidate:** A candidate that an agent received in an offer or answer from its peer.

**Default Destination/Candidate:** The default destination for a component of a media stream is the transport address that would be used by an agent that is not ICE aware. For the RTP component, the default IP address is in the c line of the SDP, and the port is in the m line. For the RTCP component, it is in the rtcp attribute when present, and when not present, the IP address is in the c line and 1 plus the port is in the m line. A default candidate for a component is one whose transport address matches the default destination for that component.

**Candidate Pair:** A pairing containing a local candidate and a remote candidate.

**Check, Connectivity Check, STUN Check:** A STUN Binding request transaction for the purposes of verifying connectivity. A check is sent from the local candidate to the remote candidate of a candidate pair.

**Check List:** An ordered set of candidate pairs that an agent will use to generate checks.

**Ordinary Check:** A connectivity check generated by an agent as a consequence of a timer that fires periodically, instructing it to send a check.

**Triggered Check:** A connectivity check generated as a consequence of the receipt of a connectivity check from the peer.

**Valid List:** An ordered set of candidate pairs for a media stream that have been validated by a successful STUN transaction.

**Full:** An ICE implementation that performs the complete set of functionality defined by this specification.

**Lite:** An ICE implementation that omits certain functions, implementing only as much as is necessary for a peer implementation that is full to gain the benefits of ICE. Lite implementations do not maintain any of the state machines and do not generate connectivity checks.

**Controlling Agent:** The ICE agent that is responsible for selecting the final choice of candidate pairs and signaling them through STUN and an updated offer, if needed. In any session, one agent is always controlling. The other is the controlled agent.

**Controlled Agent:** An ICE agent that waits for the controlling agent to select the final choice of candidate pairs.

**Regular Nomination:** The process of picking a valid candidate pair for media traffic by validating the pair with one STUN request, and then picking it by sending a second STUN request with a flag indicating its nomination.

**Aggressive Nomination:** The process of picking a valid candidate pair for media traffic by including a flag in every STUN request, such that the first one to produce a valid candidate pair is used for media.

**Nominated:** If a valid candidate pair has its nominated flag set, it means that it may be selected by ICE for sending and receiving media.

**Selected Pair, Selected Candidate:** The candidate pair selected by ICE for sending and receiving media is called the selected pair, and each of its candidates is called the selected candidate.

#### 4. Sending the Initial Offer

In order to send the initial offer in an offer/answer exchange, an agent must (1) gather candidates, (2) prioritize them, (3) eliminate redundant candidates, (4) choose default candidates, and then (5) formulate and send the SDP offer. All but the last of these five steps differ for full and lite implementations.

##### 4.1. Full Implementation Requirements

###### 4.1.1. Gathering Candidates

An agent gathers candidates when it believes that communication is imminent. An offerer can do this based on a user interface cue, or based on an explicit request to initiate a session. Every candidate

is a transport address. It also has a type and a base. Four types are defined and gathered by this specification -- host candidates, server reflexive candidates, peer reflexive candidates, and relayed candidates. The server reflexive candidates are gathered using STUN or TURN, and relayed candidates are obtained through TURN. Peer reflexive candidates are obtained in later phases of ICE, as a consequence of connectivity checks. The base of a candidate is the candidate that an agent must send from when using that candidate.

#### 4.1.1.1. Host Candidates

The first step is to gather host candidates. Host candidates are obtained by binding to ports (typically ephemeral) on a IP address attached to an interface (physical or virtual, including VPN interfaces) on the host.

For each UDP media stream the agent wishes to use, the agent SHOULD obtain a candidate for each component of the media stream on each IP address that the host has. It obtains each candidate by binding to a UDP port on the specific IP address. A host candidate (and indeed every candidate) is always associated with a specific component for which it is a candidate. Each component has an ID assigned to it, called the component ID. For RTP-based media streams, the RTP itself has a component ID of 1, and RTCP a component ID of 2. If an agent is using RTCP, it MUST obtain a candidate for it. If an agent is using both RTP and RTCP, it would end up with 2\*K host candidates if an agent has K IP addresses.

The base for each host candidate is set to the candidate itself.

#### 4.1.1.2. Server Reflexive and Relayed Candidates

Agents SHOULD obtain relayed candidates and SHOULD obtain server reflexive candidates. These requirements are at SHOULD strength to allow for provider variation. Use of STUN and TURN servers may be unnecessary in closed networks where agents are never connected to the public Internet or to endpoints outside of the closed network. In such cases, a full implementation would be used for agents that are dual stack or multihomed, to select a host candidate. Use of TURN servers is expensive, and when ICE is being used, they will only be utilized when both endpoints are behind NATs that perform address and port dependent mapping. Consequently, some deployments might consider this use case to be marginal, and elect not to use TURN servers. If an agent does not gather server reflexive or relayed candidates, it is RECOMMENDED that the functionality be implemented and just disabled through configuration, so that it can be re-enabled through configuration if conditions change in the future.

If an agent is gathering both relayed and server reflexive candidates, it uses a TURN server. If it is gathering just server reflexive candidates, it uses a STUN server.

The agent next pairs each host candidate with the STUN or TURN server with which it is configured or has discovered by some means. If a STUN or TURN server is configured, it is RECOMMENDED that a domain name be configured, and the DNS procedures in [RFC5389] (using SRV records with the "stun" service) be used to discover the STUN server, and the DNS procedures in [RFC5766] (using SRV records with the "turn" service) be used to discover the TURN server.

This specification only considers usage of a single STUN or TURN server. When there are multiple choices for that single STUN or TURN server (when, for example, they are learned through DNS records and multiple results are returned), an agent SHOULD use a single STUN or TURN server (based on its IP address) for all candidates for a particular session. This improves the performance of ICE. The result is a set of pairs of host candidates with STUN or TURN servers. The agent then chooses one pair, and sends a Binding or Allocate request to the server from that host candidate. Binding requests to a STUN server are not authenticated, and any ALTERNATE-SERVER attribute in a response is ignored. Agents MUST support the backwards compatibility mode for the Binding request defined in [RFC5389]. Allocate requests SHOULD be authenticated using a long-term credential obtained by the client through some other means.

Every  $T_a$  milliseconds thereafter, the agent can generate another new STUN or TURN transaction. This transaction can either be a retry of a previous transaction that failed with a recoverable error (such as authentication failure), or a transaction for a new host candidate and STUN or TURN server pair. The agent SHOULD NOT generate transactions more frequently than one every  $T_a$  milliseconds. See Section 16 for guidance on how to set  $T_a$  and the STUN retransmit timer,  $RTO$ .

The agent will receive a Binding or Allocate response. A successful Allocate response will provide the agent with a server reflexive candidate (obtained from the mapped address) and a relayed candidate in the XOR-RELAYED-ADDRESS attribute. If the Allocate request is rejected because the server lacks resources to fulfill it, the agent SHOULD instead send a Binding request to obtain a server reflexive candidate. A Binding response will provide the agent with only a server reflexive candidate (also obtained from the mapped address). The base of the server reflexive candidate is the host candidate from which the Allocate or Binding request was sent. The base of a relayed candidate is that candidate itself. If a relayed candidate

is identical to a host candidate (which can happen in rare cases), the relayed candidate MUST be discarded.

#### 4.1.1.3. Computing Foundations

Finally, the agent assigns each candidate a foundation. The foundation is an identifier, scoped within a session. Two candidates MUST have the same foundation ID when all of the following are true:

- o they are of the same type (host, relayed, server reflexive, or peer reflexive).
- o their bases have the same IP address (the ports can be different).
- o for reflexive and relayed candidates, the STUN or TURN servers used to obtain them have the same IP address.
- o they were obtained using the same transport protocol (TCP, UDP, etc.).

Similarly, two candidates MUST have different foundations if their types are different, their bases have different IP addresses, the STUN or TURN servers used to obtain them have different IP addresses, or their transport protocols are different.

#### 4.1.1.4. Keeping Candidates Alive

Once server reflexive and relayed candidates are allocated, they MUST be kept alive until ICE processing has completed, as described in Section 8.3. For server reflexive candidates learned through a Binding request, the bindings MUST be kept alive by additional Binding requests to the server. Refreshes for allocations are done using the Refresh transaction, as described in [RFC5766]. The Refresh requests will also refresh the server reflexive candidate.

#### 4.1.2. Prioritizing Candidates

The prioritization process results in the assignment of a priority to each candidate. Each candidate for a media stream MUST have a unique priority that MUST be a positive integer between 1 and  $(2^{31} - 1)$ . This priority will be used by ICE to determine the order of the connectivity checks and the relative preference for candidates.

An agent SHOULD compute this priority using the formula in Section 4.1.2.1 and choose its parameters using the guidelines in Section 4.1.2.2. If an agent elects to use a different formula, ICE will take longer to converge since both agents will not be coordinated in their checks.

#### 4.1.2.1. Recommended Formula

When using the formula, an agent computes the priority by determining a preference for each type of candidate (server reflexive, peer reflexive, relayed, and host), and, when the agent is multihomed, choosing a preference for its IP addresses. These two preferences are then combined to compute the priority for a candidate. That priority is computed using the following formula:

$$\text{priority} = (2^{24}) * (\text{type preference}) + \\ (2^8) * (\text{local preference}) + \\ (2^0) * (256 - \text{component ID})$$

The type preference MUST be an integer from 0 to 126 inclusive, and represents the preference for the type of the candidate (where the types are local, server reflexive, peer reflexive, and relayed). A 126 is the highest preference, and a 0 is the lowest. Setting the value to a 0 means that candidates of this type will only be used as a last resort. The type preference MUST be identical for all candidates of the same type and MUST be different for candidates of different types. The type preference for peer reflexive candidates MUST be higher than that of server reflexive candidates. Note that candidates gathered based on the procedures of Section 4.1.1 will never be peer reflexive candidates; candidates of these type are learned from the connectivity checks performed by ICE.

The local preference MUST be an integer from 0 to 65535 inclusive. It represents a preference for the particular IP address from which the candidate was obtained, in cases where an agent is multihomed. 65535 represents the highest preference, and a zero, the lowest. When there is only a single IP address, this value SHOULD be set to 65535. More generally, if there are multiple candidates for a particular component for a particular media stream that have the same type, the local preference MUST be unique for each one. In this specification, this only happens for multihomed hosts. If a host is multihomed because it is dual stack, the local preference SHOULD be set equal to the precedence value for IP addresses described in RFC 3484 [RFC3484].

The component ID is the component ID for the candidate, and MUST be between 1 and 256 inclusive.

#### 4.1.2.2. Guidelines for Choosing Type and Local Preferences

One criterion for selection of the type and local preference values is the use of a media intermediary, such as a TURN server, VPN server, or NAT. With a media intermediary, if media is sent to that

candidate, it will first transit the media intermediary before being received. Relayed candidates are one type of candidate that involves a media intermediary. Another are host candidates obtained from a VPN interface. When media is transited through a media intermediary, it can increase the latency between transmission and reception. It can increase the packet losses, because of the additional router hops that may be taken. It may increase the cost of providing service, since media will be routed in and right back out of a media intermediary run by a provider. If these concerns are important, the type preference for relayed candidates SHOULD be lower than host candidates. The RECOMMENDED values are 126 for host candidates, 100 for server reflexive candidates, 110 for peer reflexive candidates, and 0 for relayed candidates. Furthermore, if an agent is multihomed and has multiple IP addresses, the local preference for host candidates from a VPN interface SHOULD have a priority of 0.

Another criterion for selection of preferences is IP address family. ICE works with both IPv4 and IPv6. It therefore provides a transition mechanism that allows dual-stack hosts to prefer connectivity over IPv6, but to fall back to IPv4 in case the v6 networks are disconnected (due, for example, to a failure in a 6to4 relay) [RFC3056]. It can also help with hosts that have both a native IPv6 address and a 6to4 address. In such a case, higher local preferences could be assigned to the v6 addresses, followed by the 6to4 addresses, followed by the v4 addresses. This allows a site to obtain and begin using native v6 addresses immediately, yet still fall back to 6to4 addresses when communicating with agents in other sites that do not yet have native v6 connectivity.

Another criterion for selecting preferences is security. If a user is a telecommuter, and therefore connected to a corporate network and a local home network, the user may prefer their voice traffic to be routed over the VPN in order to keep it on the corporate network when communicating within the enterprise, but use the local network when communicating with users outside of the enterprise. In such a case, a VPN address would have a higher local preference than any other address.

Another criterion for selecting preferences is topological awareness. This is most useful for candidates that make use of intermediaries. In those cases, if an agent has preconfigured or dynamically discovered knowledge of the topological proximity of the intermediaries to itself, it can use that to assign higher local preferences to candidates obtained from closer intermediaries.



#### 4.1.3. Eliminating Redundant Candidates

Next, the agent eliminates redundant candidates. A candidate is redundant if its transport address equals another candidate, and its base equals the base of that other candidate. Note that two candidates can have the same transport address yet have different bases, and these would not be considered redundant. Frequently, a server reflexive candidate and a host candidate will be redundant when the agent is not behind a NAT. The agent SHOULD eliminate the redundant candidate with the lower priority.

#### 4.1.4. Choosing Default Candidates

A candidate is said to be default if it would be the target of media from a non-ICE peer; that target is called the DEFAULT DESTINATION. If the default candidates are not selected by the ICE algorithm when communicating with an ICE-aware peer, an updated offer/answer will be required after ICE processing completes in order to "fix up" the SDP so that the default destination for media matches the candidates selected by ICE. If ICE happens to select the default candidates, no updated offer/answer is required.

An agent MUST choose a set of candidates, one for each component of each in-use media stream, to be default. A media stream is in-use if it does not have a port of zero (which is used in RFC 3264 to reject a media stream). Consequently, a media stream is in-use even if it is marked as a=inactive [RFC4566] or has a bandwidth value of zero.

It is RECOMMENDED that default candidates be chosen based on the likelihood of those candidates to work with the peer that is being contacted. It is RECOMMENDED that the default candidates are the relayed candidates (if relayed candidates are available), server reflexive candidates (if server reflexive candidates are available), and finally host candidates.

#### 4.2. Lite Implementation Requirements

Lite implementations only utilize host candidates. A lite implementation MUST, for each component of each media stream, allocate zero or one IPv4 candidates. It MAY allocate zero or more IPv6 candidates, but no more than one per each IPv6 address utilized by the host. Since there can be no more than one IPv4 candidate per component of each media stream, if an agent has multiple IPv4 addresses, it MUST choose one for allocating the candidate. If a host is dual stack, it is RECOMMENDED that it allocate one IPv4 candidate and one global IPv6 address. With the lite implementation, ICE cannot be used to dynamically choose amongst candidates. Therefore, including more than one candidate from a particular scope

is NOT RECOMMENDED, since only a connectivity check can truly determine whether to use one address or the other.

Each component has an ID assigned to it, called the component ID. For RTP-based media streams, the RTP itself has a component ID of 1, and RTCP a component ID of 2. If an agent is using RTCP, it MUST obtain candidates for it.

Each candidate is assigned a foundation. The foundation MUST be different for two candidates allocated from different IP addresses, and MUST be the same otherwise. A simple integer that increments for each IP address will suffice. In addition, each candidate MUST be assigned a unique priority amongst all candidates for the same media stream. This priority SHOULD be equal to:

$$\text{priority} = (2^{24}) * (126) + \\ (2^8) * (\text{IP precedence}) + \\ (2^0) * (256 - \text{component ID})$$

If a host is v4-only, it SHOULD set the IP precedence to 65535. If a host is v6 or dual stack, the IP precedence SHOULD be the precedence value for IP addresses described in RFC 3484 [RFC3484].

Next, an agent chooses a default candidate for each component of each media stream. If a host is IPv4 only, there would only be one candidate for each component of each media stream, and therefore that candidate is the default. If a host is IPv6 or dual stack, the selection of default is a matter of local policy. This default SHOULD be chosen such that it is the candidate most likely to be used with a peer. For IPv6-only hosts, this would typically be a globally scoped IPv6 address. For dual-stack hosts, the IPv4 address is RECOMMENDED.

#### 4.3. Encoding the SDP

The process of encoding the SDP is identical between full and lite implementations.

The agent will include an m line for each media stream it wishes to use. The ordering of media streams in the SDP is relevant for ICE. ICE will perform its connectivity checks for the first m line first, and consequently media will be able to flow for that stream first. Agents SHOULD place their most important media stream, if there is one, first in the SDP.

There will be a candidate attribute for each candidate for a particular media stream. Section 15 provides detailed rules for constructing this attribute. The attribute carries the IP address,

port, and transport protocol for the candidate, in addition to its properties that need to be signaled to the peer for ICE to work: the priority, foundation, and component ID. The candidate attribute also carries information about the candidate that is useful for diagnostics and other functions: its type and related transport addresses.

STUN connectivity checks between agents are authenticated using the short-term credential mechanism defined for STUN [RFC5389]. This mechanism relies on a username and password that are exchanged through protocol machinery between the client and server. With ICE, the offer/answer exchange is used to exchange them. The username part of this credential is formed by concatenating a username fragment from each agent, separated by a colon. Each agent also provides a password, used to compute the message integrity for requests it receives. The username fragment and password are exchanged in the ice-ufrag and ice-pwd attributes, respectively. In addition to providing security, the username provides disambiguation and correlation of checks to media streams. See Appendix B.4 for motivation.

If an agent is a lite implementation, it MUST include an "a=ice-lite" session-level attribute in its SDP. If an agent is a full implementation, it MUST NOT include this attribute.

The default candidates are added to the SDP as the default destination for media. For streams based on RTP, this is done by placing the IP address and port of the RTP candidate into the c and m lines, respectively. If the agent is utilizing RTCP, it MUST encode the RTCP candidate using the a=rtcp attribute as defined in RFC 3605 [RFC3605]. If RTCP is not in use, the agent MUST signal that using b=RS:0 and b=RR:0 as defined in RFC 3556 [RFC3556].

The transport addresses that will be the default destination for media when communicating with non-ICE peers MUST also be present as candidates in one or more a=candidate lines.

ICE provides for extensibility by allowing an offer or answer to contain a series of tokens that identify the ICE extensions used by that agent. If an agent supports an ICE extension, it MUST include the token defined for that extension in the ice-options attribute.

The following is an example SDP message that includes ICE attributes (lines folded for readability):

```
v=0
o=jdoe 2890844526 2890842807 IN IP4 10.0.1.1
s=
c=IN IP4 192.0.2.3
t=0 0
a=ice-pwd:asd88fgpdd777uzjYhagZg
a=ice-ufrag:8hhY
m=audio 45664 RTP/AVP 0
b=RS:0
b=RR:0
a=rtpmap:0 PCMU/8000
a=candidate:1 1 UDP 2130706431 10.0.1.1 8998 typ host
a=candidate:2 1 UDP 1694498815 192.0.2.3 45664 typ srflx raddr
10.0.1.1 rport 8998
```

Once an agent has sent its offer or its answer, that agent **MUST** be prepared to receive both STUN and media packets on each candidate. As discussed in Section 11.1, media packets can be sent to a candidate prior to its appearance as the default destination for media in an offer or answer.

## 5. Receiving the Initial Offer

When an agent receives an initial offer, it will check if the offerer supports ICE, determine its own role, gather candidates, prioritize them, choose default candidates, encode and send an answer, and for full implementations, form the check lists and begin connectivity checks.

### 5.1. Verifying ICE Support

The agent will proceed with the ICE procedures defined in this specification if, for each media stream in the SDP it received, the default destination for each component of that media stream appears in a candidate attribute. For example, in the case of RTP, the IP address and port in the `c` and `m` lines, respectively, appear in a candidate attribute and the value in the `rtpmap` attribute appears in a candidate attribute.

If this condition is not met, the agent **MUST** process the SDP based on normal RFC 3264 procedures, without using any of the ICE mechanisms described in the remainder of this specification with the following exceptions:

1. The agent **MUST** follow the rules of Section 10, which describe keepalive procedures for all agents.

2. If the agent is not proceeding with ICE because there were a=candidate attributes, but none that matched the default destination of the media stream, the agent MUST include an a=ice-mismatch attribute in its answer.
3. If the default candidates were relayed candidates learned through a TURN server, the agent MUST create permissions in the TURN server for the IP addresses learned from its peer in the SDP it just received. If this is not done, initial packets in the media stream from the peer may be lost.

## 5.2. Determining Role

For each session, each agent takes on a role. There are two roles -- controlling and controlled. The controlling agent is responsible for the choice of the final candidate pairs used for communications. For a full agent, this means nominating the candidate pairs that can be used by ICE for each media stream, and for generating the updated offer based on ICE's selection, when needed. For a lite implementation, being the controlling agent means selecting a candidate pair based on the ones in the offer and answer (for IPv4, there is only ever one pair), and then generating an updated offer reflecting that selection, when needed (it is never needed for an IPv4-only host). The controlled agent is told which candidate pairs to use for each media stream, and does not generate an updated offer to signal this information. The sections below describe in detail the actual procedures followed by controlling and controlled nodes.

The rules for determining the role and the impact on behavior are as follows:

Both agents are full: The agent that generated the offer which started the ICE processing MUST take the controlling role, and the other MUST take the controlled role. Both agents will form check lists, run the ICE state machines, and generate connectivity checks. The controlling agent will execute the logic in Section 8.1 to nominate pairs that will be selected by ICE, and then both agents end ICE as described in Section 8.1.2. In unusual cases, described in Appendix B.11, it is possible for both agents to mistakenly believe they are controlled or controlling. To resolve this, each agent MUST select a random number, called the tie-breaker, uniformly distributed between 0 and  $(2^{64}) - 1$  (that is, a 64-bit positive integer). This number is used in connectivity checks to detect and repair this case, as described in Section 7.1.2.2.

One agent full, one lite: The full agent MUST take the controlling role, and the lite agent MUST take the controlled role. The full agent will form check lists, run the ICE state machines, and generate connectivity checks. That agent will execute the logic in Section 8.1 to nominate pairs that will be selected by ICE, and use the logic in Section 8.1.2 to end ICE. The lite implementation will just listen for connectivity checks, receive them and respond to them, and then conclude ICE as described in Section 8.2. For the lite implementation, the state of ICE processing for each media stream is considered to be Running, and the state of ICE overall is Running.

Both lite: The agent that generated the offer which started the ICE processing MUST take the controlling role, and the other MUST take the controlled role. In this case, no connectivity checks are ever sent. Rather, once the offer/answer exchange completes, each agent performs the processing described in Section 8 without connectivity checks. It is possible that both agents will believe they are controlled or controlling. In the latter case, the conflict is resolved through glare detection capabilities in the signaling protocol carrying the offer/answer exchange. The state of ICE processing for each media stream is considered to be Running, and the state of ICE overall is Running.

Once roles are determined for a session, they persist unless ICE is restarted. An ICE restart (Section 9.1) causes a new selection of roles and tie-breakers.

### 5.3. Gathering Candidates

The process for gathering candidates at the answerer is identical to the process for the offerer as described in Section 4.1.1 for full implementations and Section 4.2 for lite implementations. It is RECOMMENDED that this process begin immediately on receipt of the offer, prior to alerting the user. Such gathering MAY begin when an agent starts.

### 5.4. Prioritizing Candidates

The process for prioritizing candidates at the answerer is identical to the process followed by the offerer, as described in Section 4.1.2 for full implementations and Section 4.2 for lite implementations.

### 5.5. Choosing Default Candidates

The process for selecting default candidates at the answerer is identical to the process followed by the offerer, as described in Section 4.1.4 for full implementations and Section 4.2 for lite implementations.

### 5.6. Encoding the SDP

The process for encoding the SDP at the answerer is identical to the process followed by the offerer for both full and lite implementations, as described in Section 4.3.

### 5.7. Forming the Check Lists

Forming check lists is done only by full implementations. Lite implementations MUST skip the steps defined in this section.

There is one check list per in-use media stream resulting from the offer/answer exchange. To form the check list for a media stream, the agent forms candidate pairs, computes a candidate pair priority, orders the pairs by priority, prunes them, and sets their states. These steps are described in this section.

#### 5.7.1. Forming Candidate Pairs

First, the agent takes each of its candidates for a media stream (called LOCAL CANDIDATES) and pairs them with the candidates it received from its peer (called REMOTE CANDIDATES) for that media stream. In order to prevent the attacks described in Section 18.5.2, agents MAY limit the number of candidates they'll accept in an offer or answer. A local candidate is paired with a remote candidate if and only if the two candidates have the same component ID and have the same IP address version. It is possible that some of the local candidates won't get paired with remote candidates, and some of the remote candidates won't get paired with local candidates. This can happen if one agent doesn't include candidates for the all of the components for a media stream. If this happens, the number of components for that media stream is effectively reduced, and considered to be equal to the minimum across both agents of the maximum component ID provided by each agent across all components for the media stream.

In the case of RTP, this would happen when one agent provides candidates for RTCP, and the other does not. As another example, the offerer can multiplex RTP and RTCP on the same port and signals that it can do that in the SDP through an SDP attribute [RFC5761]. However, since the offerer doesn't know if the answerer can perform

such multiplexing, the offerer includes candidates for RTP and RTCP on separate ports, so that the offer has two components per media stream. If the answerer can perform such multiplexing, it would include just a single component for each candidate - for the combined RTP/RTCP mux. ICE would end up acting as if there was just a single component for this candidate.

The candidate pairs whose local and remote candidates are both the default candidates for a particular component is called, unsurprisingly, the default candidate pair for that component. This is the pair that would be used to transmit media if both agents had not been ICE aware.

In order to aid understanding, Figure 6 shows the relationships between several key concepts -- transport addresses, candidates, candidate pairs, and check lists, in addition to indicating the main properties of candidates and candidate pairs.



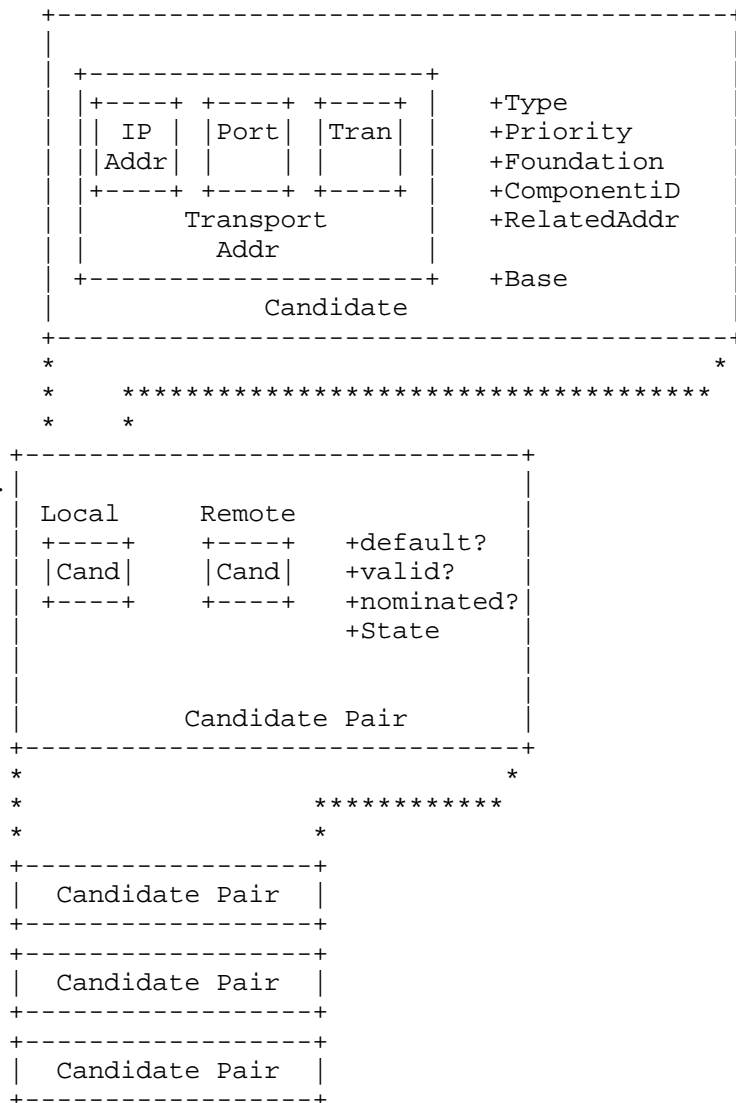

Check  
List

Figure 6: Conceptual Diagram of a Check List

### 5.7.2. Computing Pair Priority and Ordering Pairs

Once the pairs are formed, a candidate pair priority is computed. Let  $G$  be the priority for the candidate provided by the controlling agent. Let  $D$  be the priority for the candidate provided by the controlled agent. The priority for a pair is computed as:

$$\text{pair priority} = 2^{32} * \text{MIN}(G,D) + 2 * \text{MAX}(G,D) + (G > D ? 1 : 0)$$

Where  $G > D ? 1 : 0$  is an expression whose value is 1 if  $G$  is greater than  $D$ , and 0 otherwise. Once the priority is assigned, the agent sorts the candidate pairs in decreasing order of priority. If two pairs have identical priority, the ordering amongst them is arbitrary.

### 5.7.3. Pruning the Pairs

This sorted list of candidate pairs is used to determine a sequence of connectivity checks that will be performed. Each check involves sending a request from a local candidate to a remote candidate. Since an agent cannot send requests directly from a reflexive candidate, but only from its base, the agent next goes through the sorted list of candidate pairs. For each pair where the local candidate is server reflexive, the server reflexive candidate MUST be replaced by its base. Once this has been done, the agent MUST prune the list. This is done by removing a pair if its local and remote candidates are identical to the local and remote candidates of a pair higher up on the priority list. The result is a sequence of ordered candidate pairs, called the check list for that media stream.

In addition, in order to limit the attacks described in Section 18.5.2, an agent MUST limit the total number of connectivity checks the agent performs across all check lists to a specific value, and this value MUST be configurable. A default of 100 is RECOMMENDED. This limit is enforced by discarding the lower-priority candidate pairs until there are less than 100. It is RECOMMENDED that a lower value be utilized when possible, set to the maximum number of plausible checks that might be seen in an actual deployment configuration. The requirement for configuration is meant to provide a tool for fixing this value in the field if, once deployed, it is found to be problematic.

### 5.7.4. Computing States

Each candidate pair in the check list has a foundation and a state. The foundation is the combination of the foundations of the local and remote candidates in the pair. The state is assigned once the check list for each media stream has been computed. There are five potential values that the state can have:

Waiting: A check has not been performed for this pair, and can be performed as soon as it is the highest-priority Waiting pair on the check list.

In-Progress: A check has been sent for this pair, but the transaction is in progress.

Succeeded: A check for this pair was already done and produced a successful result.

Failed: A check for this pair was already done and failed, either never producing any response or producing an unrecoverable failure response.

Frozen: A check for this pair hasn't been performed, and it can't yet be performed until some other check succeeds, allowing this pair to unfreeze and move into the Waiting state.

As ICE runs, the pairs will move between states as shown in Figure 7.

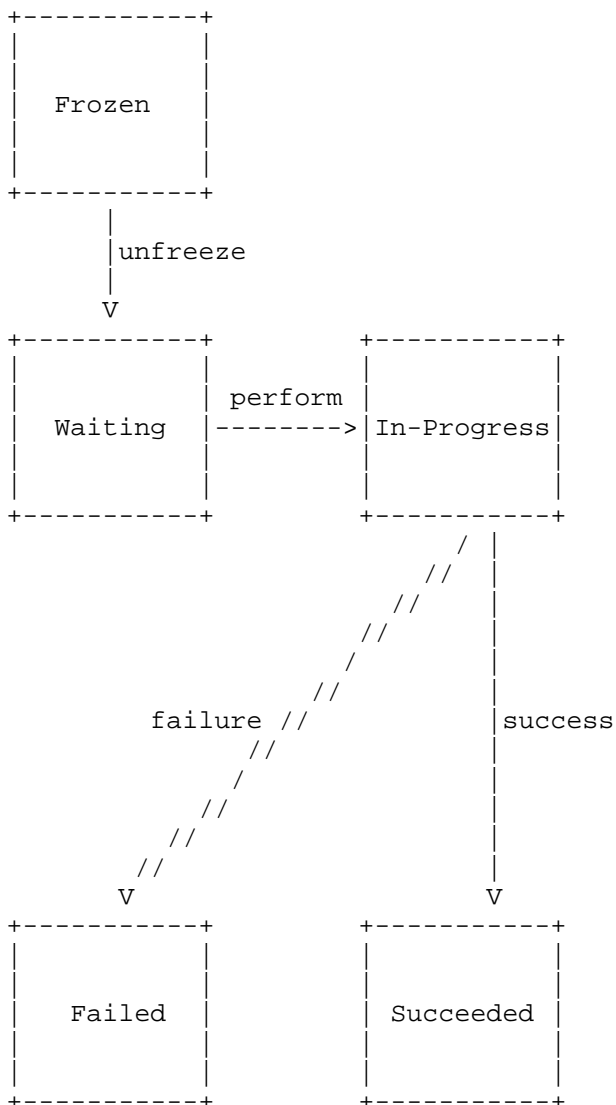

Figure 7: Pair State FSM

The initial states for each pair in a check list are computed by performing the following sequence of steps:

1. The agent sets all of the pairs in each check list to the Frozen state.

2. The agent examines the check list for the first media stream (a media stream is the first media stream when it is described by the first m line in the SDP offer and answer). For that media stream:
  - \* For all pairs with the same foundation, it sets the state of the pair with the lowest component ID to Waiting. If there is more than one such pair, the one with the highest priority is used.

One of the check lists will have some number of pairs in the Waiting state, and the other check lists will have all of their pairs in the Frozen state. A check list with at least one pair that is Waiting is called an active check list, and a check list with all pairs Frozen is called a frozen check list.

The check list itself is associated with a state, which captures the state of ICE checks for that media stream. There are three states:

**Running:** In this state, ICE checks are still in progress for this media stream.

**Completed:** In this state, ICE checks have produced nominated pairs for each component of the media stream. Consequently, ICE has succeeded and media can be sent.

**Failed:** In this state, the ICE checks have not completed successfully for this media stream.

When a check list is first constructed as the consequence of an offer/answer exchange, it is placed in the Running state.

ICE processing across all media streams also has a state associated with it. This state is equal to Running while ICE processing is under way. The state is Completed when ICE processing is complete and Failed if it failed without success. Rules for transitioning between states are described below.

## 5.8. Scheduling Checks

Checks are generated only by full implementations. Lite implementations MUST skip the steps described in this section.

An agent performs ordinary checks and triggered checks. The generation of both checks is governed by a timer that fires periodically for each media stream. The agent maintains a FIFO queue, called the triggered check queue, which contains candidate pairs for which checks are to be sent at the next available

opportunity. When the timer fires, the agent removes the top pair from the triggered check queue, performs a connectivity check on that pair, and sets the state of the candidate pair to In-Progress. If there are no pairs in the triggered check queue, an ordinary check is sent.

Once the agent has computed the check lists as described in Section 5.7, it sets a timer for each active check list. The timer fires every  $T_a * N$  seconds, where  $N$  is the number of active check lists (initially, there is only one active check list). Implementations MAY set the timer to fire less frequently than this. Implementations SHOULD take care to spread out these timers so that they do not fire at the same time for each media stream.  $T_a$  and the retransmit timer RTO are computed as described in Section 16. Multiplying by  $N$  allows this aggregate check throughput to be split between all active check lists. The first timer fires immediately, so that the agent performs a connectivity check the moment the offer/answer exchange has been done, followed by the next check  $T_a$  seconds later (since there is only one active check list).

When the timer fires and there is no triggered check to be sent, the agent MUST choose an ordinary check as follows:

- o Find the highest-priority pair in that check list that is in the Waiting state.
- o If there is such a pair:
  - \* Send a STUN check from the local candidate of that pair to the remote candidate of that pair. The procedures for forming the STUN request for this purpose are described in Section 7.1.2.
  - \* Set the state of the candidate pair to In-Progress.
- o If there is no such pair:
  - \* Find the highest-priority pair in that check list that is in the Frozen state.
  - \* If there is such a pair:
    - + Unfreeze the pair.
    - + Perform a check for that pair, causing its state to transition to In-Progress.

- \* If there is no such pair:
  - + Terminate the timer for that check list.

To compute the message integrity for the check, the agent uses the remote username fragment and password learned from the SDP from its peer. The local username fragment is known directly by the agent for its own candidate.

## 6. Receipt of the Initial Answer

This section describes the procedures that an agent follows when it receives the answer from the peer. It verifies that its peer supports ICE, determines its role, and for full implementations, forms the check list and begins performing ordinary checks.

When ICE is used with SIP, forking may result in a single offer generating a multiplicity of answers. In that case, ICE proceeds completely in parallel and independently for each answer, treating the combination of its offer and each answer as an independent offer/answer exchange, with its own set of pairs, check lists, states, and so on. The only case in which processing of one pair impacts another is freeing of candidates, discussed below in Section 8.3.

### 6.1. Verifying ICE Support

The logic at the offerer is identical to that of the answerer as described in Section 5.1, with the exception that an offerer would not ever generate a=ice-mismatch attributes in an SDP.

In some cases, the answer may omit a=candidate attributes for the media streams, and instead include an a=ice-mismatch attribute for one or more of the media streams in the SDP. This signals to the offerer that the answerer supports ICE, but that ICE processing was not used for the session because a signaling intermediary modified the default destination for media components without modifying the corresponding candidate attributes. See Section 18 for a discussion of cases where this can happen. This specification provides no guidance on how an agent should proceed in such a failure case.

### 6.2. Determining Role

The offerer follows the same procedures described for the answerer in Section 5.2.

### 6.3. Forming the Check List

Formation of check lists is performed only by full implementations. The offerer follows the same procedures described for the answerer in Section 5.7.

### 6.4. Performing Ordinary Checks

Ordinary checks are performed only by full implementations. The offerer follows the same procedures described for the answerer in Section 5.8.

## 7. Performing Connectivity Checks

This section describes how connectivity checks are performed. All ICE implementations are required to be compliant to [RFC5389], as opposed to the older [RFC3489]. However, whereas a full implementation will both generate checks (acting as a STUN client) and receive them (acting as a STUN server), a lite implementation will only receive checks, and thus will only act as a STUN server.

### 7.1. STUN Client Procedures

These procedures define how an agent sends a connectivity check, whether it is an ordinary or a triggered check. These procedures are only applicable to full implementations.

#### 7.1.1. Creating Permissions for Relayed Candidates

If the connectivity check is being sent using a relayed local candidate, the client **MUST** create a permission first if it has not already created one previously. It would have created one previously if it had told the TURN server to create a permission for the given relayed candidate towards the IP address of the remote candidate. To create the permission, the agent follows the procedures defined in [RFC5766]. The permission **MUST** be created towards the IP address of the remote candidate. It is **RECOMMENDED** that the agent defer creation of a TURN channel until ICE completes, in which case permissions for connectivity checks are normally created using a CreatePermission request. Once established, the agent **MUST** keep the permission active until ICE concludes.

#### 7.1.2. Sending the Request

The check is generated by sending a Binding request from a local candidate to a remote candidate. [RFC5389] describes how Binding requests are constructed and generated. A connectivity check **MUST**



utilize the STUN short-term credential mechanism. Support for backwards compatibility with RFC 3489 MUST NOT be used or assumed with connectivity checks. The FINGERPRINT mechanism MUST be used for connectivity checks.

ICE extends STUN by defining several new attributes, including PRIORITY, USE-CANDIDATE, ICE-CONTROLLED, and ICE-CONTROLLING. These new attributes are formally defined in Section 19.1, and their usage is described in the subsections below. These STUN extensions are applicable only to connectivity checks used for ICE.

#### 7.1.2.1. PRIORITY and USE-CANDIDATE

An agent MUST include the PRIORITY attribute in its Binding request. The attribute MUST be set equal to the priority that would be assigned, based on the algorithm in Section 4.1.2, to a peer reflexive candidate, should one be learned as a consequence of this check (see Section 7.1.3.2.1 for how peer reflexive candidates are learned). This priority value will be computed identically to how the priority for the local candidate of the pair was computed, except that the type preference is set to the value for peer reflexive candidate types.

The controlling agent MAY include the USE-CANDIDATE attribute in the Binding request. The controlled agent MUST NOT include it in its Binding request. This attribute signals that the controlling agent wishes to cease checks for this component, and use the candidate pair resulting from the check for this component. Section 8.1.1 provides guidance on determining when to include it.

#### 7.1.2.2. ICE-CONTROLLED and ICE-CONTROLLING

The agent MUST include the ICE-CONTROLLED attribute in the request if it is in the controlled role, and MUST include the ICE-CONTROLLING attribute in the request if it is in the controlling role. The content of either attribute MUST be the tie-breaker that was determined in Section 5.2. These attributes are defined fully in Section 19.1.

#### 7.1.2.3. Forming Credentials

A Binding request serving as a connectivity check MUST utilize the STUN short-term credential mechanism. The username for the credential is formed by concatenating the username fragment provided by the peer with the username fragment of the agent sending the request, separated by a colon (":"). The password is equal to the password provided by the peer. For example, consider the case where agent L is the offerer, and agent R is the answerer. Agent L

included a username fragment of LFRAG for its candidates and a password of LPASS. Agent R provided a username fragment of RFRAG and a password of RPASS. A connectivity check from L to R utilizes the username RFRAG:LFRAG and a password of RPASS. A connectivity check from R to L utilizes the username LFRAG:RFRAG and a password of LPASS. The responses utilize the same usernames and passwords as the requests (note that the USERNAME attribute is not present in the response).

#### 7.1.2.4. DiffServ Treatment

If the agent is using Diffserv Codepoint markings [RFC2475] in its media packets, it SHOULD apply those same markings to its connectivity checks.

#### 7.1.3. Processing the Response

When a Binding response is received, it is correlated to its Binding request using the transaction ID, as defined in [RFC5389], which then ties it to the candidate pair for which the Binding request was sent. This section defines additional procedures for processing Binding responses specific to this usage of STUN.

##### 7.1.3.1. Failure Cases

If the STUN transaction generates a 487 (Role Conflict) error response, the agent checks whether it included the ICE-CONTROLLED or ICE-CONTROLLING attribute in the Binding request. If the request contained the ICE-CONTROLLED attribute, the agent MUST switch to the controlling role if it has not already done so. If the request contained the ICE-CONTROLLING attribute, the agent MUST switch to the controlled role if it has not already done so. Once it has switched, the agent MUST enqueue the candidate pair whose check generated the 487 into the triggered check queue. The state of that pair is set to Waiting. When the triggered check is sent, it will contain an ICE-CONTROLLING or ICE-CONTROLLED attribute reflecting its new role. Note, however, that the tie-breaker value MUST NOT be reselected.

A change in roles will require an agent to recompute pair priorities (Section 5.7.2), since those priorities are a function of controlling and controlled roles. The change in role will also impact whether the agent is responsible for selecting nominated pairs and generating updated offers upon conclusion of ICE.

Agents MAY support receipt of ICMP errors for connectivity checks. If the STUN transaction generates an ICMP error, the agent sets the state of the pair to Failed. If the STUN transaction generates a

STUN error response that is unrecoverable (as defined in [RFC5389]) or times out, the agent sets the state of the pair to Failed.

The agent MUST check that the source IP address and port of the response equal the destination IP address and port to which the Binding request was sent, and that the destination IP address and port of the response match the source IP address and port from which the Binding request was sent. In other words, the source and destination transport addresses in the request and responses are symmetric. If they are not symmetric, the agent sets the state of the pair to Failed.

#### 7.1.3.2. Success Cases

A check is considered to be a success if all of the following are true:

- o The STUN transaction generated a success response.
- o The source IP address and port of the response equals the destination IP address and port to which the Binding request was sent.
- o The destination IP address and port of the response match the source IP address and port from which the Binding request was sent.

##### 7.1.3.2.1. Discovering Peer Reflexive Candidates

The agent checks the mapped address from the STUN response. If the transport address does not match any of the local candidates that the agent knows about, the mapped address represents a new candidate -- a peer reflexive candidate. Like other candidates, it has a type, base, priority, and foundation. They are computed as follows:

- o Its type is equal to peer reflexive.
- o Its base is set equal to the local candidate of the candidate pair from which the STUN check was sent.
- o Its priority is set equal to the value of the PRIORITY attribute in the Binding request.
- o Its foundation is selected as described in Section 4.1.1.3.

This peer reflexive candidate is then added to the list of local candidates for the media stream. Its username fragment and password are the same as all other local candidates for that media stream.

However, the peer reflexive candidate is not paired with other remote candidates. This is not necessary; a valid pair will be generated from it momentarily based on the procedures in Section 7.1.3.2.2. If an agent wishes to pair the peer reflexive candidate with other remote candidates besides the one in the valid pair that will be generated, the agent MAY generate an updated offer which includes the peer reflexive candidate. This will cause it to be paired with all other remote candidates.

#### 7.1.3.2.2. Constructing a Valid Pair

The agent constructs a candidate pair whose local candidate equals the mapped address of the response, and whose remote candidate equals the destination address to which the request was sent. This is called a valid pair, since it has been validated by a STUN connectivity check. The valid pair may equal the pair that generated the check, may equal a different pair in the check list, or may be a pair not currently on any check list. If the pair equals the pair that generated the check or is on a check list currently, it is also added to the VALID LIST, which is maintained by the agent for each media stream. This list is empty at the start of ICE processing, and fills as checks are performed, resulting in valid candidate pairs.

It will be very common that the pair will not be on any check list. Recall that the check list has pairs whose local candidates are never server reflexive; those pairs had their local candidates converted to the base of the server reflexive candidates, and then pruned if they were redundant. When the response to the STUN check arrives, the mapped address will be reflexive if there is a NAT between the two. In that case, the valid pair will have a local candidate that doesn't match any of the pairs in the check list.

If the pair is not on any check list, the agent computes the priority for the pair based on the priority of each candidate, using the algorithm in Section 5.7. The priority of the local candidate depends on its type. If it is not peer reflexive, it is equal to the priority signaled for that candidate in the SDP. If it is peer reflexive, it is equal to the PRIORITY attribute the agent placed in the Binding request that just completed. The priority of the remote candidate is taken from the SDP of the peer. If the candidate does not appear there, then the check must have been a triggered check to a new remote candidate. In that case, the priority is taken as the value of the PRIORITY attribute in the Binding request that triggered the check that just completed. The pair is then added to the VALID LIST.

#### 7.1.3.2.3. Updating Pair States

The agent sets the state of the pair that \*generated\* the check to Succeeded. Note that, the pair which \*generated\* the check may be different than the valid pair constructed in Section 7.1.3.2.2 as a consequence of the response. The success of this check might also cause the state of other checks to change as well. The agent MUST perform the following two steps:

1. The agent changes the states for all other Frozen pairs for the same media stream and same foundation to Waiting. Typically, but not always, these other pairs will have different component IDs.
2. If there is a pair in the valid list for every component of this media stream (where this is the actual number of components being used, in cases where the number of components signaled in the SDP differs from offerer to answerer), the success of this check may unfreeze checks for other media streams. Note that this step is followed not just the first time the valid list under consideration has a pair for every component, but every subsequent time a check succeeds and adds yet another pair to that valid list. The agent examines the check list for each other media stream in turn:
  - \* If the check list is active, the agent changes the state of all Frozen pairs in that check list whose foundation matches a pair in the valid list under consideration to Waiting.
  - \* If the check list is frozen, and there is at least one pair in the check list whose foundation matches a pair in the valid list under consideration, the state of all pairs in the check list whose foundation matches a pair in the valid list under consideration is set to Waiting. This will cause the check list to become active, and ordinary checks will begin for it, as described in Section 5.8.
  - \* If the check list is frozen, and there are no pairs in the check list whose foundation matches a pair in the valid list under consideration, the agent
    - + groups together all of the pairs with the same foundation, and
    - + for each group, sets the state of the pair with the lowest component ID to Waiting. If there is more than one such pair, the one with the highest priority is used.

#### 7.1.3.2.4. Updating the Nominated Flag

If the agent was a controlling agent, and it had included a USE-CANDIDATE attribute in the Binding request, the valid pair generated from that check has its nominated flag set to true. This flag indicates that this valid pair should be used for media if it is the highest-priority one amongst those whose nominated flag is set. This may conclude ICE processing for this media stream or all media streams; see Section 8.

If the agent is the controlled agent, the response may be the result of a triggered check that was sent in response to a request that itself had the USE-CANDIDATE attribute. This case is described in Section 7.2.1.5, and may now result in setting the nominated flag for the pair learned from the original request.

#### 7.1.3.3. Check List and Timer State Updates

Regardless of whether the check was successful or failed, the completion of the transaction may require updating of check list and timer states.

If all of the pairs in the check list are now either in the Failed or Succeeded state:

- o If there is not a pair in the valid list for each component of the media stream, the state of the check list is set to Failed.
- o For each frozen check list, the agent
  - \* groups together all of the pairs with the same foundation, and
  - \* for each group, sets the state of the pair with the lowest component ID to Waiting. If there is more than one such pair, the one with the highest priority is used.

If none of the pairs in the check list are in the Waiting or Frozen state, the check list is no longer considered active, and will not count towards the value of N in the computation of timers for ordinary checks as described in Section 5.8.

## 7.2. STUN Server Procedures

An agent **MUST** be prepared to receive a Binding request on the base of each candidate it included in its most recent offer or answer. This requirement holds even if the peer is a lite implementation.

The agent MUST use a short-term credential to authenticate the request and perform a message integrity check. The agent MUST consider the username to be valid if it consists of two values separated by a colon, where the first value is equal to the username fragment generated by the agent in an offer or answer for a session in-progress. It is possible (and in fact very likely) that an offerer will receive a Binding request prior to receiving the answer from its peer. If this happens, the agent MUST immediately generate a response (including computation of the mapped address as described in Section 7.2.1.2). The agent has sufficient information at this point to generate the response; the password from the peer is not required. Once the answer is received, it MUST proceed with the remaining steps required, namely, 7.2.1.3, 7.2.1.4, and 7.2.1.5 for full implementations. In cases where multiple STUN requests are received before the answer, this may cause several pairs to be queued up in the triggered check queue.

An agent MUST NOT utilize the ALTERNATE-SERVER mechanism, and MUST NOT support the backwards-compatibility mechanisms to RFC 3489. It MUST utilize the FINGERPRINT mechanism.

If the agent is using Diffserv Codepoint markings [RFC2475] in its media packets, it SHOULD apply those same markings to its responses to Binding requests. The same would apply to any layer 2 markings the endpoint might be applying to media packets.

#### 7.2.1. Additional Procedures for Full Implementations

This subsection defines the additional server procedures applicable to full implementations.

##### 7.2.1.1. Detecting and Repairing Role Conflicts

Normally, the rules for selection of a role in Section 5.2 will result in each agent selecting a different role -- one controlling and one controlled. However, in unusual call flows, typically utilizing third party call control, it is possible for both agents to select the same role. This section describes procedures for checking for this case and repairing it.

An agent MUST examine the Binding request for either the ICE-CONTROLLING or ICE-CONTROLLED attribute. It MUST follow these procedures:

- o If neither ICE-CONTROLLING nor ICE-CONTROLLED is present in the request, the peer agent may have implemented a previous version of this specification. There may be a conflict, but it cannot be detected.

- o If the agent is in the controlling role, and the ICE-CONTROLLING attribute is present in the request:
  - \* If the agent's tie-breaker is larger than or equal to the contents of the ICE-CONTROLLING attribute, the agent generates a Binding error response and includes an ERROR-CODE attribute with a value of 487 (Role Conflict) but retains its role.
  - \* If the agent's tie-breaker is less than the contents of the ICE-CONTROLLING attribute, the agent switches to the controlled role.
- o If the agent is in the controlled role, and the ICE-CONTROLLED attribute is present in the request:
  - \* If the agent's tie-breaker is larger than or equal to the contents of the ICE-CONTROLLED attribute, the agent switches to the controlling role.
  - \* If the agent's tie-breaker is less than the contents of the ICE-CONTROLLED attribute, the agent generates a Binding error response and includes an ERROR-CODE attribute with a value of 487 (Role Conflict) but retains its role.
- o If the agent is in the controlled role and the ICE-CONTROLLING attribute was present in the request, or the agent was in the controlling role and the ICE-CONTROLLED attribute was present in the request, there is no conflict.

A change in roles will require an agent to recompute pair priorities (Section 5.7.2), since those priorities are a function of controlling and controlled roles. The change in role will also impact whether the agent is responsible for selecting nominated pairs and generated updated offers upon conclusion of ICE.

The remaining sections in Section 7.2.1 are followed if the server generated a successful response to the Binding request, even if the agent changed roles.

#### 7.2.1.2. Computing Mapped Address

For requests being received on a relayed candidate, the source transport address used for STUN processing (namely, generation of the XOR-MAPPED-ADDRESS attribute) is the transport address as seen by the TURN server. That source transport address will be present in the XOR-PEER-ADDRESS attribute of a Data Indication message, if the Binding request was delivered through a Data Indication. If the



Binding request was delivered through a ChannelData message, the source transport address is the one that was bound to the channel.

#### 7.2.1.3. Learning Peer Reflexive Candidates

If the source transport address of the request does not match any existing remote candidates, it represents a new peer reflexive remote candidate. This candidate is constructed as follows:

- o The priority of the candidate is set to the PRIORITY attribute from the request.
- o The type of the candidate is set to peer reflexive.
- o The foundation of the candidate is set to an arbitrary value, different from the foundation for all other remote candidates. If any subsequent offer/answer exchanges contain this peer reflexive candidate in the SDP, it will signal the actual foundation for the candidate.
- o The component ID of this candidate is set to the component ID for the local candidate to which the request was sent.

This candidate is added to the list of remote candidates. However, the agent does not pair this candidate with any local candidates.

#### 7.2.1.4. Triggered Checks

Next, the agent constructs a pair whose local candidate is equal to the transport address on which the STUN request was received, and a remote candidate equal to the source transport address where the request came from (which may be the peer reflexive remote candidate that was just learned). The local candidate will either be a host candidate (for cases where the request was not received through a relay) or a relayed candidate (for cases where it is received through a relay). The local candidate can never be a server reflexive candidate. Since both candidates are known to the agent, it can obtain their priorities and compute the candidate pair priority. This pair is then looked up in the check list. There can be one of several outcomes:

- o If the pair is already on the check list:
  - \* If the state of that pair is Waiting or Frozen, a check for that pair is enqueued into the triggered check queue if not already present.

- \* If the state of that pair is In-Progress, the agent cancels the in-progress transaction. Cancellation means that the agent will not retransmit the request, will not treat the lack of response to be a failure, but will wait the duration of the transaction timeout for a response. In addition, the agent MUST create a new connectivity check for that pair (representing a new STUN Binding request transaction) by enqueueing the pair in the triggered check queue. The state of the pair is then changed to Waiting.
- \* If the state of the pair is Failed, it is changed to Waiting and the agent MUST create a new connectivity check for that pair (representing a new STUN Binding request transaction), by enqueueing the pair in the triggered check queue.
- \* If the state of that pair is Succeeded, nothing further is done.

These steps are done to facilitate rapid completion of ICE when both agents are behind NAT.

- o If the pair is not already on the check list:
  - \* The pair is inserted into the check list based on its priority.
  - \* Its state is set to Waiting.
  - \* The pair is enqueued into the triggered check queue.

When a triggered check is to be sent, it is constructed and processed as described in Section 7.1.2. These procedures require the agent to know the transport address, username fragment, and password for the peer. The username fragment for the remote candidate is equal to the part after the colon of the USERNAME in the Binding request that was just received. Using that username fragment, the agent can check the SDP messages received from its peer (there may be more than one in cases of forking), and find this username fragment. The corresponding password is then selected.

#### 7.2.1.5. Updating the Nominated Flag

If the Binding request received by the agent had the USE-CANDIDATE attribute set, and the agent is in the controlled role, the agent looks at the state of the pair computed in Section 7.2.1.4:

- o If the state of this pair is Succeeded, it means that the check generated by this pair produced a successful response. This would have caused the agent to construct a valid pair when that success

response was received (see Section 7.1.3.2.2). The agent now sets the nominated flag in the valid pair to true. This may end ICE processing for this media stream; see Section 8.

- o If the state of this pair is In-Progress, if its check produces a successful result, the resulting valid pair has its nominated flag set when the response arrives. This may end ICE processing for this media stream when it arrives; see Section 8.

#### 7.2.2. Additional Procedures for Lite Implementations

If the check that was just received contained a USE-CANDIDATE attribute, the agent constructs a candidate pair whose local candidate is equal to the transport address on which the request was received, and whose remote candidate is equal to the source transport address of the request that was received. This candidate pair is assigned an arbitrary priority, and placed into a list of valid candidates called the valid list. The agent sets the nominated flag for that pair to true. ICE processing is considered complete for a media stream if the valid list contains a candidate pair for each component.

### 8. Concluding ICE Processing

This section describes how an agent completes ICE.

#### 8.1. Procedures for Full Implementations

Concluding ICE involves nominating pairs by the controlling agent and updating of state machinery.

##### 8.1.1. Nominating Pairs

The controlling agent nominates pairs to be selected by ICE by using one of two techniques: regular nomination or aggressive nomination. If its peer has a lite implementation, an agent **MUST** use a regular nomination algorithm. If its peer is using ICE options (present in an ice-options attribute from the peer) that the agent does not understand, the agent **MUST** use a regular nomination algorithm. If its peer is a full implementation and isn't using any ICE options or is using ICE options understood by the agent, the agent **MAY** use either the aggressive or the regular nomination algorithm. However, the regular algorithm is **RECOMMENDED** since it provides greater stability.

#### 8.1.1.1. Regular Nomination

With regular nomination, the agent lets some number of checks complete, each of which omit the USE-CANDIDATE attribute. Once one or more checks complete successfully for a component of a media stream, valid pairs are generated and added to the valid list. The agent lets the checks continue until some stopping criterion is met, and then picks amongst the valid pairs based on an evaluation criterion. The criteria for stopping the checks and for evaluating the valid pairs is entirely a matter of local optimization.

When the controlling agent selects the valid pair, it repeats the check that produced this valid pair (by enqueueing the pair that generated the check into the triggered check queue), this time with the USE-CANDIDATE attribute. This check should succeed (since the previous did), causing the nominated flag of that and only that pair to be set. Consequently, there will be only a single nominated pair in the valid list for each component, and when the state of the check list moves to completed, that exact pair is selected by ICE for sending and receiving media for that component.

Regular nomination provides the most flexibility, since the agent has control over the stopping and selection criteria for checks. The only requirement is that the agent MUST eventually pick one and only one candidate pair and generate a check for that pair with the USE-CANDIDATE attribute present. Regular nomination also improves ICE's resilience to variations in implementation (see Section 14). Regular nomination is also more stable, allowing both agents to converge on a single pair for media without any transient selections, which can happen with the aggressive algorithm. The drawback of regular nomination is that it is guaranteed to increase latencies because it requires an additional check to be done.

#### 8.1.1.2. Aggressive Nomination

With aggressive nomination, the controlling agent includes the USE-CANDIDATE attribute in every check it sends. Once the first check for a component succeeds, it will be added to the valid list and have its nominated flag set. When all components have a nominated pair in the valid list, media can begin to flow using the highest priority nominated pair. However, because the agent included the USE-CANDIDATE attribute in all of its checks, another check may yet complete, causing another valid pair to have its nominated flag set. ICE always selects the highest-priority nominated candidate pair from the valid list as the one used for media. Consequently, the selected pair may actually change briefly as ICE checks complete, resulting in a set of transient selections until it stabilizes.

### 8.1.2. Updating States

For both controlling and controlled agents, the state of ICE processing depends on the presence of nominated candidate pairs in the valid list and on the state of the check list. Note that, at any time, more than one of the following cases can apply:

- o If there are no nominated pairs in the valid list for a media stream and the state of the check list is Running, ICE processing continues.
- o If there is at least one nominated pair in the valid list for a media stream and the state of the check list is Running:
  - \* The agent MUST remove all Waiting and Frozen pairs in the check list and triggered check queue for the same component as the nominated pairs for that media stream.
  - \* If an In-Progress pair in the check list is for the same component as a nominated pair, the agent SHOULD cease retransmissions for its check if its pair priority is lower than the lowest-priority nominated pair for that component.
- o Once there is at least one nominated pair in the valid list for every component of at least one media stream and the state of the check list is Running:
  - \* The agent MUST change the state of processing for its check list for that media stream to Completed.
  - \* The agent MUST continue to respond to any checks it may still receive for that media stream, and MUST perform triggered checks if required by the processing of Section 7.2.
  - \* The agent MUST continue retransmitting any In-Progress checks for that check list.
  - \* The agent MAY begin transmitting media for this media stream as described in Section 11.1.
- o Once the state of each check list is Completed:
  - \* The agent sets the state of ICE processing overall to Completed.
  - \* If an agent is controlling, it examines the highest-priority nominated candidate pair for each component of each media stream. If any of those candidate pairs differ from the

default candidate pairs in the most recent offer/answer exchange, the controlling agent MUST generate an updated offer as described in Section 9. If the controlling agent is using an aggressive nomination algorithm, this may result in several updated offers as the pairs selected for media change. An agent MAY delay sending the offer for a brief interval (one second is RECOMMENDED) in order to allow the selected pairs to stabilize.

- o If the state of the check list is Failed, ICE has not been able to complete for this media stream. The correct behavior depends on the state of the check lists for other media streams:
  - \* If all check lists are Failed, ICE processing overall is considered to be in the Failed state, and the agent SHOULD consider the session a failure, SHOULD NOT restart ICE, and the controlling agent SHOULD terminate the entire session.
  - \* If at least one of the check lists for other media streams is Completed, the controlling agent SHOULD remove the failed media stream from the session in its updated offer.
  - \* If none of the check lists for other media streams are Completed, but at least one is Running, the agent SHOULD let ICE continue.

## 8.2. Procedures for Lite Implementations

Concluding ICE for a lite implementation is relatively straightforward. There are two cases to consider:

The implementation is lite, and its peer is full.

The implementation is lite, and its peer is lite.

The effect of ICE concluding is that the agent can free any allocated host candidates that were not utilized by ICE, as described in Section 8.3.

### 8.2.1. Peer Is Full

In this case, the agent will receive connectivity checks from its peer. When an agent has received a connectivity check that includes the USE-CANDIDATE attribute for each component of a media stream, the state of ICE processing for that media stream moves from Running to Completed. When the state of ICE processing for all media streams is Completed, the state of ICE processing overall is Completed.

The lite implementation will never itself determine that ICE processing has failed for a media stream; rather, the full peer will make that determination and then remove or restart the failed media stream in a subsequent offer.

#### 8.2.2. Peer Is Lite

Once the offer/answer exchange has completed, both agents examine their candidates and those of its peer. For each media stream, each agent pairs up its own candidates with the candidates of its peer for that media stream. Two candidates are paired up when they are for the same component, utilize the same transport protocol (UDP in this specification), and are from the same IP address family (IPv4 or IPv6).

- o If there is a single pair per component, that pair is added to the Valid list. If all of the components for a media stream had one pair, the state of ICE processing for that media stream is set to Completed. If all media streams are Completed, the state of ICE processing is set to Completed overall. This will always be the case for implementations that are IPv4 only.
- o If there is more than one pair per component:
  - \* The agent MUST select a pair based on local policy. Since this case only arises for IPv6, it is RECOMMENDED that an agent follow the procedures of RFC 3484 [RFC3484] to select a single pair.
  - \* The agent adds the selected pair for each component to the valid list. As described in Section 11.1, this will permit media to begin flowing. However, it is possible (and in fact likely) that both agents have chosen different pairs.
  - \* To reconcile this, the controlling agent MUST send an updated offer as described in Section 9.1.3, which will include the remote-candidates attribute.
  - \* The agent MUST NOT update the state of ICE processing when the offer is sent. If this subsequent offer completes, the controlling agent MUST change the state of ICE processing to Completed for all media streams, and the state of ICE processing overall to Completed. The states for the controlled agent are set based on the logic in Section 9.2.3.

### 8.3. Freeing Candidates

#### 8.3.1. Full Implementation Procedures

The procedures in Section 8 require that an agent continue to listen for STUN requests and continue to generate triggered checks for a media stream, even once processing for that stream completes. The rules in this section describe when it is safe for an agent to cease sending or receiving checks on a candidate that was not selected by ICE, and then free the candidate.

When ICE is used with SIP, and an offer is forked to multiple recipients, ICE proceeds in parallel and independently with each answerer, all using the same local candidates. Once ICE processing has reached the Completed state for all peers for media streams using those candidates, the agent SHOULD wait an additional three seconds, and then it MAY cease responding to checks or generating triggered checks on that candidate. It MAY free the candidate at that time. Freeing of server reflexive candidates is never explicit; it happens by lack of a keepalive. The three-second delay handles cases when aggressive nomination is used, and the selected pairs can quickly change after ICE has completed.

#### 8.3.2. Lite Implementation Procedures

A lite implementation MAY free candidates not selected by ICE as soon as ICE processing has reached the Completed state for all peers for all media streams using those candidates.

### 9. Subsequent Offer/Answer Exchanges

Either agent MAY generate a subsequent offer at any time allowed by RFC 3264 [RFC3264]. The rules in Section 8 will cause the controlling agent to send an updated offer at the conclusion of ICE processing when ICE has selected different candidate pairs from the default pairs. This section defines rules for construction of subsequent offers and answers.

Should a subsequent offer be rejected, ICE processing continues as if the subsequent offer had never been made.



## 9.1. Generating the Offer

### 9.1.1. Procedures for All Implementations

#### 9.1.1.1. ICE Restarts

An agent MAY restart ICE processing for an existing media stream. An ICE restart, as the name implies, will cause all previous states of ICE processing to be flushed and checks to start anew. The only difference between an ICE restart and a brand new media session is that, during the restart, media can continue to be sent to the previously validated pair.

An agent MUST restart ICE for a media stream if:

- o The offer is being generated for the purposes of changing the target of the media stream. In other words, if an agent wants to generate an updated offer that, had ICE not been in use, would result in a new value for the destination of a media component.
- o An agent is changing its implementation level. This typically only happens in third party call control use cases, where the entity performing the signaling is not the entity receiving the media, and it has changed the target of media mid-session to another entity that has a different ICE implementation.

These rules imply that setting the IP address in the c line to 0.0.0.0 will cause an ICE restart. Consequently, ICE implementations MUST NOT utilize this mechanism for call hold, and instead MUST use a=inactive and a=sendonly as described in [RFC3264].

To restart ICE, an agent MUST change both the ice-pwd and the ice-ufrag for the media stream in an offer. Note that it is permissible to use a session-level attribute in one offer, but to provide the same ice-pwd or ice-ufrag as a media-level attribute in a subsequent offer. This is not a change in password, just a change in its representation, and does not cause an ICE restart.

An agent sets the rest of the fields in the SDP for this media stream as it would in an initial offer of this media stream (see Section 4.3). Consequently, the set of candidates MAY include some, none, or all of the previous candidates for that stream and MAY include a totally new set of candidates gathered as described in Section 4.1.1.

#### 9.1.1.2. Removing a Media Stream

If an agent removes a media stream by setting its port to zero, it MUST NOT include any candidate attributes for that media stream and SHOULD NOT include any other ICE-related attributes defined in Section 15 for that media stream.

#### 9.1.1.3. Adding a Media Stream

If an agent wishes to add a new media stream, it sets the fields in the SDP for this media stream as if this was an initial offer for that media stream (see Section 4.3). This will cause ICE processing to begin for this media stream.

### 9.1.2. Procedures for Full Implementations

This section describes additional procedures for full implementations, covering existing media streams.

The username fragments, password, and implementation level MUST remain the same as used previously. If an agent needs to change one of these, it MUST restart ICE for that media stream.

Additional behavior depends on the state ICE processing for that media stream.

#### 9.1.2.1. Existing Media Streams with ICE Running

If an agent generates an updated offer including a media stream that was previously established, and for which ICE checks are in the Running state, the agent follows the procedures defined here.

An agent MUST include candidate attributes for all local candidates it had signaled previously for that media stream. The properties of that candidate as signaled in SDP -- the priority, foundation, type, and related transport address -- SHOULD remain the same. The IP address, port, and transport protocol, which fundamentally identify that candidate, MUST remain the same (if they change, it would be a new candidate). The component ID MUST remain the same. The agent MAY include additional candidates it did not offer previously, but which it has gathered since the last offer/answer exchange, including peer reflexive candidates.

The agent MAY change the default destination for media. As with initial offers, there MUST be a set of candidate attributes in the offer matching this default destination.

#### 9.1.2.2. Existing Media Streams with ICE Completed

If an agent generates an updated offer including a media stream that was previously established, and for which ICE checks are in the Completed state, the agent follows the procedures defined here.

The default destination for media (i.e., the values of the IP addresses and ports in the m and c lines used for that media stream) MUST be the local candidate from the highest-priority nominated pair in the valid list for each component. This "fixes" the default destination for media to equal the destination ICE has selected for media.

The agent MUST include candidate attributes for candidates matching the default destination for each component of the media stream, and MUST NOT include any other candidates.

In addition, if the agent is controlling, it MUST include the a=remote-candidates attribute for each media stream whose check list is in the Completed state. The attribute contains the remote candidates from the highest-priority nominated pair in the valid list for each component of that media stream. It is needed to avoid a race condition whereby the controlling agent chooses its pairs, but the updated offer beats the connectivity checks to the controlled agent, which doesn't even know these pairs are valid, let alone selected. See Appendix B.6 for elaboration on this race condition.

#### 9.1.3. Procedures for Lite Implementations

##### 9.1.3.1. Existing Media Streams with ICE Running

This section describes procedures for lite implementations for existing streams for which ICE is running.

A lite implementation MUST include all of its candidates for each component of each media stream in an a=candidate attribute in any subsequent offer. These candidates are formed identically to the procedures for initial offers, as described in Section 4.2.

A lite implementation MUST NOT add additional host candidates in a subsequent offer. If an agent needs to offer additional candidates, it MUST restart ICE.

The username fragments, password, and implementation level MUST remain the same as used previously. If an agent needs to change one of these, it MUST restart ICE for that media stream.

#### 9.1.3.2. Existing Media Streams with ICE Completed

If ICE has completed for a media stream, the default destination for that media stream MUST be set to the remote candidate of the candidate pair for that component in the valid list. For a lite implementation, there is always just a single candidate pair in the valid list for each component of a media stream. Additionally, the agent MUST include a candidate attribute for each default destination.

Additionally, if the agent is controlling (which only happens when both agents are lite), the agent MUST include the `a=remote-candidates` attribute for each media stream. The attribute contains the remote candidates from the candidate pairs in the valid list (one pair for each component of each media stream).

### 9.2. Receiving the Offer and Generating an Answer

#### 9.2.1. Procedures for All Implementations

When receiving a subsequent offer within an existing session, an agent MUST reapply the verification procedures in Section 5.1 without regard to the results of verification from any previous offer/answer exchanges. Indeed, it is possible that a previous offer/answer exchange resulted in ICE not being used, but it is used as a consequence of a subsequent exchange.

##### 9.2.1.1. Detecting ICE Restart

If the offer contained a change in the `a=ice-ufrag` or `a=ice-pwd` attributes compared to the previous SDP from the peer, it indicates that ICE is restarting for this media stream. If all media streams are restarting, then ICE is restarting overall.

If ICE is restarting for a media stream:

- o The agent MUST change the `a=ice-ufrag` and `a=ice-pwd` attributes in the answer.
- o The agent MAY change its implementation level in the answer.

An agent sets the rest of the fields in the SDP for this media stream as it would in an initial answer to this media stream (see Section 4.3). Consequently, the set of candidates MAY include some, none, or all of the previous candidates for that stream and MAY include a totally new set of candidates gathered as described in Section 4.1.1.

#### 9.2.1.2. New Media Stream

If the offer contains a new media stream, the agent sets the fields in the answer as if it had received an initial offer containing that media stream (see Section 4.3). This will cause ICE processing to begin for this media stream.

#### 9.2.1.3. Removed Media Stream

If an offer contains a media stream whose port is zero, the agent MUST NOT include any candidate attributes for that media stream in its answer and SHOULD NOT include any other ICE-related attributes defined in Section 15 for that media stream.

### 9.2.2. Procedures for Full Implementations

Unless the agent has detected an ICE restart from the offer, the username fragments, password, and implementation level MUST remain the same as used previously. If an agent needs to change one of these it MUST restart ICE for that media stream by generating an offer; ICE cannot be restarted in an answer.

Additional behaviors depend on the state of ICE processing for that media stream.

#### 9.2.2.1. Existing Media Streams with ICE Running and no remote-candidates

If ICE is running for a media stream, and the offer for that media stream lacked the remote-candidates attribute, the rules for construction of the answer are identical to those for the offerer as described in Section 9.1.2.1.

#### 9.2.2.2. Existing Media Streams with ICE Completed and no remote-candidates

If ICE is Completed for a media stream, and the offer for that media stream lacked the remote-candidates attribute, the rules for construction of the answer are identical to those for the offerer as described in Section 9.1.2.2, except that the answerer MUST NOT include the a=remote-candidates attribute in the answer.

#### 9.2.2.3. Existing Media Streams and remote-candidates

A controlled agent will receive an offer with the a=remote-candidates attribute for a media stream when its peer has concluded ICE processing for that media stream. This attribute is present in the offer to deal with a race condition between the receipt of the offer,

and the receipt of the Binding response that tells the answerer the candidate that will be selected by ICE. See Appendix B.6 for an explanation of this race condition. Consequently, processing of an offer with this attribute depends on the winner of the race.

The agent forms a candidate pair for each component of the media stream by:

- o Setting the remote candidate equal to the offerer's default destination for that component (e.g., the contents of the m and c lines for RTP, and the a=rtcp attribute for RTCP)
- o Setting the local candidate equal to the transport address for that same component in the a=remote-candidates attribute in the offer.

The agent then sees if each of these candidate pairs is present in the valid list. If a particular pair is not in the valid list, the check has "lost" the race. Call such a pair a "losing pair".

The agent finds all the pairs in the check list whose remote candidates equal the remote candidate in the losing pair:

- o If none of the pairs are In-Progress, and at least one is Failed, it is most likely that a network failure, such as a network partition or serious packet loss, has occurred. The agent SHOULD generate an answer for this media stream as if the remote-candidates attribute had not been present, and then restart ICE for this stream.
- o If at least one of the pairs is In-Progress, the agent SHOULD wait for those checks to complete, and as each completes, redo the processing in this section until there are no losing pairs.

Once there are no losing pairs, the agent can generate the answer. It MUST set the default destination for media to the candidates in the remote-candidates attribute from the offer (each of which will now be the local candidate of a candidate pair in the valid list). It MUST include a candidate attribute in the answer for each candidate in the remote-candidates attribute in the offer.

### 9.2.3. Procedures for Lite Implementations

If the received offer contains the remote-candidates attribute for a media stream, the agent forms a candidate pair for each component of the media stream by:

- o Setting the remote candidate equal to the offerer's default destination for that component (e.g., the contents of the m and c lines for RTP, and the a=rtcp attribute for RTCP).
- o Setting the local candidate equal to the transport address for that same component in the a=remote-candidates attribute in the offer.

It then places those candidates into the Valid list for the media stream. The state of ICE processing for that media stream is set to Completed.

Furthermore, if the agent believed it was controlling, but the offer contained the remote-candidates attribute, both agents believe they are controlling. In this case, both would have sent updated offers around the same time. However, the signaling protocol carrying the offer/answer exchanges will have resolved this glare condition, so that one agent is always the 'winner' by having its offer received before its peer has sent an offer. The winner takes the role of controlled, so that the loser (the answerer under consideration in this section) MUST change its role to controlled. Consequently, if the agent was going to send an updated offer since, based on the rules in Section 8.2.2, it was controlling, it no longer needs to.

Besides the potential role change, change in the Valid list, and state changes, the construction of the answer is performed identically to the construction of an offer as described in Section 9.1.3.

### 9.3. Updating the Check and Valid Lists

#### 9.3.1. Procedures for Full Implementations

##### 9.3.1.1. ICE Restarts

The agent MUST remember the highest-priority nominated pairs in the Valid list for each component of the media stream, called the previous selected pairs, prior to the restart. The agent will continue to send media using these pairs, as described in Section 11.1. Once these destinations are noted, the agent MUST flush the valid and check lists, and then recompute the check list and its states as described in Section 5.7.

##### 9.3.1.2. New Media Stream

If the offer/answer exchange added a new media stream, the agent MUST create a new check list for it (and an empty Valid list to start of course), as described in Section 5.7.

#### 9.3.1.3. Removed Media Stream

If the offer/answer exchange removed a media stream, or an answer rejected an offered media stream, an agent MUST flush the Valid list for that media stream. It MUST terminate any STUN transactions in progress for that media stream. An agent MUST remove the check list for that media stream and cancel any pending ordinary checks for it.

#### 9.3.1.4. ICE Continuing for Existing Media Stream

The valid list is not affected by an updated offer/answer exchange unless ICE is restarting.

If an agent is in the Running state for that media stream, the check list is updated (the check list is irrelevant if the state is completed). To do that, the agent recomputes the check list using the procedures described in Section 5.7. If a pair on the new check list was also on the previous check list, and its state was Waiting, In-Progress, Succeeded, or Failed, its state is copied over. Otherwise, its state is set to Frozen.

If none of the check lists are active (meaning that the pairs in each check list are Frozen), the full-mode agent sets the first pair in the check list for the first media stream to Waiting, and then sets the state of all other pairs in that check list for the same component ID and with the same foundation to Waiting as well.

Next, the agent goes through each check list, starting with the highest-priority pair. If a pair has a state of Succeeded, and it has a component ID of 1, then all Frozen pairs in the same check list with the same foundation whose component IDs are not 1 have their state set to Waiting. If, for a particular check list, there are pairs for each component of that media stream in the Succeeded state, the agent moves the state of all Frozen pairs for the first component of all other media streams (and thus in different check lists) with the same foundation to Waiting.

#### 9.3.2. Procedures for Lite Implementations

If ICE is restarting for a media stream, the agent MUST start a new Valid list for that media stream. It MUST remember the pairs in the previous Valid list for each component of the media stream, called the previous selected pairs, and continue to send media there as described in Section 11.1. The state of ICE processing for each media stream MUST change to Running, and the state of ICE processing MUST change to Running.



## 10. Keepalives

All endpoints MUST send keepalives for each media session. These keepalives serve the purpose of keeping NAT bindings alive for the media session. These keepalives MUST be sent regardless of whether the media stream is currently inactive, sendonly, recvonly, or sendrecv, and regardless of the presence or value of the bandwidth attribute. These keepalives MUST be sent even if ICE is not being utilized for the session at all. The keepalive SHOULD be sent using a format that is supported by its peer. ICE endpoints allow for STUN-based keepalives for UDP streams, and as such, STUN keepalives MUST be used when an agent is a full ICE implementation and is communicating with a peer that supports ICE (lite or full). An agent can determine that its peer supports ICE by the presence of a=candidate attributes for each media session. If the peer does not support ICE, the choice of a packet format for keepalives is a matter of local implementation. A format that allows packets to easily be sent in the absence of actual media content is RECOMMENDED. Examples of formats that readily meet this goal are RTP No-Op [NO-OP-RTP], and in cases where both sides support it, RTP comfort noise [RFC3389]. If the peer doesn't support any formats that are particularly well suited for keepalives, an agent SHOULD send RTP packets with an incorrect version number, or some other form of error that would cause them to be discarded by the peer.

If there has been no packet sent on the candidate pair ICE is using for a media component for Tr seconds (where packets include those defined for the component (RTP or RTCP) and previous keepalives), an agent MUST generate a keepalive on that pair. Tr SHOULD be configurable and SHOULD have a default of 15 seconds. Tr MUST NOT be configured to less than 15 seconds. Alternatively, if an agent has a dynamic way to discover the binding lifetimes of the intervening NATs, it can use that value to determine Tr. Administrators deploying ICE in more controlled networking environments SHOULD set Tr to the longest duration possible in their environment.

If STUN is being used for keepalives, a STUN Binding Indication is used [RFC5389]. The Indication MUST NOT utilize any authentication mechanism. It SHOULD contain the FINGERPRINT attribute to aid in demultiplexing, but SHOULD NOT contain any other attributes. It is used solely to keep the NAT bindings alive. The Binding Indication is sent using the same local and remote candidates that are being used for media. Though Binding Indications are used for keepalives, an agent MUST be prepared to receive a connectivity check as well. If a connectivity check is received, a response is generated as discussed in [RFC5389], but there is no impact on ICE processing otherwise.

An agent MUST begin the keepalive processing once ICE has selected candidates for usage with media, or media begins to flow, whichever happens first. Keepalives end once the session terminates or the media stream is removed.

## 11. Media Handling

### 11.1. Sending Media

Procedures for sending media differ for full and lite implementations.

#### 11.1.1. Procedures for Full Implementations

Agents always send media using a candidate pair, called the selected candidate pair. An agent will send media to the remote candidate in the selected pair (setting the destination address and port of the packet equal to that remote candidate), and will send it from the local candidate of the selected pair. When the local candidate is server or peer reflexive, media is originated from the base. Media sent from a relayed candidate is sent from the base through that TURN server, using procedures defined in [RFC5766].

If the local candidate is a relayed candidate, it is RECOMMENDED that an agent create a channel on the TURN server towards the remote candidate. This is done using the procedures for channel creation as defined in Section 11 of [RFC5766].

The selected pair for a component of a media stream is:

- o empty if the state of the check list for that media stream is Running, and there is no previous selected pair for that component due to an ICE restart
- o equal to the previous selected pair for a component of a media stream if the state of the check list for that media stream is Running, and there was a previous selected pair for that component due to an ICE restart
- o equal to the highest-priority nominated pair for that component in the valid list if the state of the check list is Completed

If the selected pair for at least one component of a media stream is empty, an agent MUST NOT send media for any component of that media stream. If the selected pair for each component of a media stream has a value, an agent MAY send media for all components of that media stream.

Note that the selected pair for a component of a media stream may not equal the default pair for that same component from the most recent offer/answer exchange. When this happens, the selected pair is used for media, not the default pair. When ICE first completes, if the selected pairs aren't a match for the default pairs, the controlling agent sends an updated offer/answer exchange to remedy this disparity. However, until that updated offer arrives, there will not be a match. Furthermore, in very unusual cases, the default candidates in the updated offer/answer will not be a match.

#### 11.1.2. Procedures for Lite Implementations

A lite implementation MUST NOT send media until it has a Valid list that contains a candidate pair for each component of that media stream. Once that happens, the agent MAY begin sending media packets. To do that, it sends media to the remote candidate in the pair (setting the destination address and port of the packet equal to that remote candidate), and will send it from the local candidate.

#### 11.1.3. Procedures for All Implementations

ICE has interactions with jitter buffer adaptation mechanisms. An RTP stream can begin using one candidate, and switch to another one, though this happens rarely with ICE. The newer candidate may result in RTP packets taking a different path through the network -- one with different delay characteristics. As discussed below, agents are encouraged to re-adjust jitter buffers when there are changes in source or destination address of media packets. Furthermore, many audio codecs use the marker bit to signal the beginning of a talkspurt, for the purposes of jitter buffer adaptation. For such codecs, it is RECOMMENDED that the sender set the marker bit [RFC3550] when an agent switches transmission of media from one candidate pair to another.

#### 11.2. Receiving Media

ICE implementations MUST be prepared to receive media on each component on any candidates provided for that component in the most recent offer/answer exchange (in the case of RTP, this would include both RTP and RTCP if candidates were provided for both).

It is RECOMMENDED that, when an agent receives an RTP packet with a new source or destination IP address for a particular media stream, that the agent re-adjust its jitter buffers.

RFC 3550 [RFC3550] describes an algorithm in Section 8.2 for detecting synchronization source (SSRC) collisions and loops. These algorithms are based, in part, on seeing different source transport

addresses with the same SSRC. However, when ICE is used, such changes will sometimes occur as the media streams switch between candidates. An agent will be able to determine that a media stream is from the same peer as a consequence of the STUN exchange that proceeds media transmission. Thus, if there is a change in source transport address, but the media packets come from the same peer agent, this SHOULD NOT be treated as an SSRC collision.

## 12. Usage with SIP

### 12.1. Latency Guidelines

ICE requires a series of STUN-based connectivity checks to take place between endpoints. These checks start from the answerer on generation of its answer, and start from the offerer when it receives the answer. These checks can take time to complete, and as such, the selection of messages to use with offers and answers can affect perceived user latency. Two latency figures are of particular interest. These are the post-pickup delay and the post-dial delay. The post-pickup delay refers to the time between when a user "answers the phone" and when any speech they utter can be delivered to the caller. The post-dial delay refers to the time between when a user enters the destination address for the user and ringback begins as a consequence of having successfully started ringing the phone of the called party.

Two cases can be considered -- one where the offer is present in the initial INVITE and one where it is in a response.

#### 12.1.1. Offer in INVITE

To reduce post-dial delays, it is RECOMMENDED that the caller begin gathering candidates prior to actually sending its initial INVITE. This can be started upon user interface cues that a call is pending, such as activity on a keypad or the phone going offhook.

If an offer is received in an INVITE request, the answerer SHOULD begin to gather its candidates on receipt of the offer and then generate an answer in a provisional response once it has completed that process. ICE requires that a provisional response with an SDP be transmitted reliably. This can be done through the existing Provisional Response Acknowledgment (PRACK) mechanism [RFC3262] or through an optimization that is specific to ICE. With this optimization, provisional responses containing an SDP answer that begins ICE processing for one or more media streams can be sent reliably without RFC 3262. To do this, the agent retransmits the provisional response with the exponential backoff timers described in RFC 3262. Retransmits MUST cease on receipt of a STUN Binding

request for one of the media streams signaled in that SDP (because receipt of a Binding request indicates the offerer has received the answer) or on transmission of the answer in a 2xx response. If the peer agent is lite, there will never be a STUN Binding request. In such a case, the agent MUST cease retransmitting the 18x after sending it four times (ICE will actually work even if the peer never receives the 18x; however, experience has shown that sending it is important for middleboxes and firewall traversal). If no Binding request is received prior to the last retransmit, the agent does not consider the session terminated. Despite the fact that the provisional response will be delivered reliably, the rules for when an agent can send an updated offer or answer do not change from those specified in RFC 3262. Specifically, if the INVITE contained an offer, the same answer appears in all of the 1xx and in the 2xx response to the INVITE. Only after that 2xx has been sent can an updated offer/answer exchange occur. This optimization SHOULD NOT be used if both agents support PRACK. Note that the optimization is very specific to provisional response carrying answers that start ICE processing; it is not a general technique for 1xx reliability.

Alternatively, an agent MAY delay sending an answer until the 200 OK; however, this results in a poor user experience and is NOT RECOMMENDED.

Once the answer has been sent, the agent SHOULD begin its connectivity checks. Once candidate pairs for each component of a media stream enter the valid list, the answerer can begin sending media on that media stream.

However, prior to this point, any media that needs to be sent towards the caller (such as SIP early media [RFC3960]) MUST NOT be transmitted. For this reason, implementations SHOULD delay alerting the called party until candidates for each component of each media stream have entered the valid list. In the case of a PSTN gateway, this would mean that the setup message into the PSTN is delayed until this point. Doing this increases the post-dial delay, but has the effect of eliminating 'ghost rings'. Ghost rings are cases where the called party hears the phone ring, picks up, but hears nothing and cannot be heard. This technique works without requiring support for, or usage of, preconditions [RFC3312], since it's a localized decision. It also has the benefit of guaranteeing that not a single packet of media will get clipped, so that post-pickup delay is zero. If an agent chooses to delay local alerting in this way, it SHOULD generate a 180 response once alerting begins.

### 12.1.2. Offer in Response

In addition to uses where the offer is in an INVITE, and the answer is in the provisional and/or 200 OK response, ICE works with cases where the offer appears in the response. In such cases, which are common in third party call control [RFC3725], ICE agents SHOULD generate their offers in a reliable provisional response (which MUST utilize RFC 3262), and not alert the user on receipt of the INVITE. The answer will arrive in a PRACK. This allows for ICE processing to take place prior to alerting, so that there is no post-pickup delay, at the expense of increased call setup delays. Once ICE completes, the callee can alert the user and then generate a 200 OK when they answer. The 200 OK would contain no SDP, since the offer/answer exchange has completed.

Alternatively, agents MAY place the offer in a 2xx instead (in which case the answer comes in the ACK). When this happens, the callee will alert the user on receipt of the INVITE, and the ICE exchanges will take place only after the user answers. This has the effect of reducing call setup delay, but can cause substantial post-pickup delays and media clipping.

### 12.2. SIP Option Tags and Media Feature Tags

[RFC5768] specifies a SIP option tag and media feature tag for usage with ICE. ICE implementations using SIP SHOULD support this specification, which uses a feature tag in registrations to facilitate interoperability through signaling intermediaries.

### 12.3. Interactions with Forking

ICE interacts very well with forking. Indeed, ICE fixes some of the problems associated with forking. Without ICE, when a call forks and the caller receives multiple incoming media streams, it cannot determine which media stream corresponds to which callee.

With ICE, this problem is resolved. The connectivity checks which occur prior to transmission of media carry username fragments, which in turn are correlated to a specific callee. Subsequent media packets that arrive on the same candidate pair as the connectivity check will be associated with that same callee. Thus, the caller can perform this correlation as long as it has received an answer.

### 12.4. Interactions with Preconditions

Quality of Service (QoS) preconditions, which are defined in RFC 3312 [RFC3312] and RFC 4032 [RFC4032], apply only to the transport addresses listed as the default targets for media in an offer/answer.

If ICE changes the transport address where media is received, this change is reflected in an updated offer that changes the default destination for media to match ICE's selection. As such, it appears like any other re-INVITE would, and is fully treated in RFCs 3312 and 4032, which apply without regard to the fact that the destination for media is changing due to ICE negotiations occurring "in the background".

Indeed, an agent SHOULD NOT indicate that QoS preconditions have been met until the checks have completed and selected the candidate pairs to be used for media.

ICE also has (purposeful) interactions with connectivity preconditions [SDP-PRECON]. Those interactions are described there. Note that the procedures described in Section 12.1 describe their own type of "preconditions", albeit with less functionality than those provided by the explicit preconditions in [SDP-PRECON].

#### 12.5. Interactions with Third Party Call Control

ICE works with Flows I, III, and IV as described in [RFC3725]. Flow I works without the controller supporting or being aware of ICE. Flow IV will work as long as the controller passes along the ICE attributes without alteration. Flow II is fundamentally incompatible with ICE; each agent will believe itself to be the answerer and thus never generate a re-INVITE.

The flows for continued operation, as described in Section 7 of RFC 3725, require additional behavior of ICE implementations to support. In particular, if an agent receives a mid-dialog re-INVITE that contains no offer, it MUST restart ICE for each media stream and go through the process of gathering new candidates. Furthermore, that list of candidates SHOULD include the ones currently being used for media.

#### 13. Relationship with ANAT

RFC 4091 [RFC4091], the Alternative Network Address Types (ANAT) Semantics for the SDP grouping framework, and RFC 4092 [RFC4092], its usage with SIP, define a mechanism for indicating that an agent can support both IPv4 and IPv6 for a media stream, and it does so by including two m lines, one for v4 and one for v6. This is similar to ICE, which allows for an agent to indicate multiple transport addresses using the candidate attribute. However, ANAT relies on static selection to pick between choices, rather than a dynamic connectivity check used by ICE.

This specification deprecates RFC 4091 and RFC 4092. Instead, agents wishing to support dual stack will utilize ICE.

#### 14. Extensibility Considerations

This specification makes very specific choices about how both agents in a session coordinate to arrive at the set of candidate pairs that are selected for media. It is anticipated that future specifications will want to alter these algorithms, whether they are simple changes like timer tweaks or larger changes like a revamp of the priority algorithm. When such a change is made, providing interoperability between the two agents in a session is critical.

First, ICE provides the `a=ice-options` SDP attribute. Each extension or change to ICE is associated with a token. When an agent supporting such an extension or change generates an offer or an answer, it **MUST** include the token for that extension in this attribute. This allows each side to know what the other side is doing. This attribute **MUST NOT** be present if the agent doesn't support any ICE extensions or changes.

At this time, no IANA registry or registration procedures are defined for these option tags. At time of writing, it is unclear whether ICE changes and extensions will be sufficiently common to warrant a registry.

One of the complications in achieving interoperability is that ICE relies on a distributed algorithm running on both agents to converge on an agreed set of candidate pairs. If the two agents run different algorithms, it can be difficult to guarantee convergence on the same candidate pairs. The regular nomination procedure described in Section 8 eliminates some of the tight coordination by delegating the selection algorithm completely to the controlling agent. Consequently, when a controlling agent is communicating with a peer that supports options it doesn't know about, the agent **MUST** run a regular nomination algorithm. When regular nomination is used, ICE will converge perfectly even when both agents use different pair prioritization algorithms. One of the keys to such convergence is triggered checks, which ensure that the nominated pair is validated by both agents. Consequently, any future ICE enhancements **MUST** preserve triggered checks.

ICE is also extensible to other media streams beyond RTP, and for transport protocols beyond UDP. Extensions to ICE for non-RTP media streams need to specify how many components they utilize, and assign component IDs to them, starting at 1 for the most important component ID. Specifications for new transport protocols must define how, if at all, various steps in the ICE processing differ from UDP.



## 15. Grammar

This specification defines seven new SDP attributes -- the "candidate", "remote-candidates", "ice-lite", "ice-mismatch", "ice-ufraq", "ice-pwd", and "ice-options" attributes.

## 15.1. "candidate" Attribute

The candidate attribute is a media-level attribute only. It contains a transport address for a candidate that can be used for connectivity checks.

The syntax of this attribute is defined using Augmented BNF as defined in RFC 5234 [RFC5234]:

```

candidate-attribute = "candidate" ":" foundation SP component-id SP
                    transport SP
                    priority SP
                    connection-address SP ;from RFC 4566
                    port ;port from RFC 4566
                    SP cand-type
                    [SP rel-addr]
                    [SP rel-port]
                    *(SP extension-att-name SP
                      extension-att-value)

foundation          = 1*32ice-char
component-id        = 1*5DIGIT
transport           = "UDP" / transport-extension
transport-extension = token ; from RFC 3261
priority            = 1*10DIGIT
cand-type           = "typ" SP candidate-types
candidate-types     = "host" / "srflx" / "prflx" / "relay" / token
rel-addr            = "raddr" SP connection-address
rel-port            = "rport" SP port
extension-att-name  = byte-string ;from RFC 4566
extension-att-value = byte-string
ice-char            = ALPHA / DIGIT / "+" / "/"

```

This grammar encodes the primary information about a candidate: its IP address, port and transport protocol, and its properties: the foundation, component ID, priority, type, and related transport address:

<connection-address>: is taken from RFC 4566 [RFC4566]. It is the IP address of the candidate, allowing for IPv4 addresses, IPv6 addresses, and fully qualified domain names (FQDNs). When parsing this field, an agent can differentiate an IPv4 address and an IPv6

address by presence of a colon in its value - the presence of a colon indicates IPv6. An agent MUST ignore candidate lines that include candidates with IP address versions that are not supported or recognized. An IP address SHOULD be used, but an FQDN MAY be used in place of an IP address. In that case, when receiving an offer or answer containing an FQDN in an a=candidate attribute, the FQDN is looked up in the DNS first using an AAAA record (assuming the agent supports IPv6), and if no result is found or the agent only supports IPv4, using an A. If the DNS query returns more than one IP address, one is chosen, and then used for the remainder of ICE processing.

<port>: is also taken from RFC 4566 [RFC4566]. It is the port of the candidate.

<transport>: indicates the transport protocol for the candidate. This specification only defines UDP. However, extensibility is provided to allow for future transport protocols to be used with ICE, such as TCP or the Datagram Congestion Control Protocol (DCCP) [RFC4340].

<foundation>: is composed of 1 to 32 <ice-char>s. It is an identifier that is equivalent for two candidates that are of the same type, share the same base, and come from the same STUN server. The foundation is used to optimize ICE performance in the Frozen algorithm.

<component-id>: is a positive integer between 1 and 256 that identifies the specific component of the media stream for which this is a candidate. It MUST start at 1 and MUST increment by 1 for each component of a particular candidate. For media streams based on RTP, candidates for the actual RTP media MUST have a component ID of 1, and candidates for RTCP MUST have a component ID of 2. Other types of media streams that require multiple components MUST develop specifications that define the mapping of components to component IDs. See Section 14 for additional discussion on extending ICE to new media streams.

<priority>: is a positive integer between 1 and (2\*\*31 - 1).

<cand-type>: encodes the type of candidate. This specification defines the values "host", "srflx", "prflx", and "relay" for host, server reflexive, peer reflexive, and relayed candidates, respectively. The set of candidate types is extensible for the future.

<rel-addr> and <rel-port>: convey transport addresses related to the candidate, useful for diagnostics and other purposes. <rel-addr> and <rel-port> MUST be present for server reflexive, peer reflexive, and relayed candidates. If a candidate is server or peer reflexive, <rel-addr> and <rel-port> are equal to the base for that server or peer reflexive candidate. If the candidate is relayed, <rel-addr> and <rel-port> is equal to the mapped address in the Allocate response that provided the client with that relayed candidate (see Appendix B.3 for a discussion of its purpose). If the candidate is a host candidate, <rel-addr> and <rel-port> MUST be omitted.

The candidate attribute can itself be extended. The grammar allows for new name/value pairs to be added at the end of the attribute. An implementation MUST ignore any name/value pairs it doesn't understand.

### 15.2. "remote-candidates" Attribute

The syntax of the "remote-candidates" attribute is defined using Augmented BNF as defined in RFC 5234 [RFC5234]. The remote-candidates attribute is a media-level attribute only.

```
remote-candidate-att = "remote-candidates" ":" remote-candidate
                      0*(SP remote-candidate)
remote-candidate = component-ID SP connection-address SP port
```

The attribute contains a connection-address and port for each component. The ordering of components is irrelevant. However, a value MUST be present for each component of a media stream. This attribute MUST be included in an offer by a controlling agent for a media stream that is Completed, and MUST NOT be included in any other case.

### 15.3. "ice-lite" and "ice-mismatch" Attributes

The syntax of the "ice-lite" and "ice-mismatch" attributes, both of which are flags, is:

```
ice-lite           = "ice-lite"
ice-mismatch       = "ice-mismatch"
```

"ice-lite" is a session-level attribute only, and indicates that an agent is a lite implementation. "ice-mismatch" is a media-level attribute only, and when present in an answer, indicates that the offer arrived with a default destination for a media component that didn't have a corresponding candidate attribute.

#### 15.4. "ice-ufrag" and "ice-pwd" Attributes

The "ice-ufrag" and "ice-pwd" attributes convey the username fragment and password used by ICE for message integrity. Their syntax is:

```
ice-pwd-att      = "ice-pwd" ":" password
ice-ufrag-att   = "ice-ufrag" ":" ufrag
password        = 22*256ice-char
ufrag           = 4*256ice-char
```

The "ice-pwd" and "ice-ufrag" attributes can appear at either the session-level or media-level. When present in both, the value in the media-level takes precedence. Thus, the value at the session-level is effectively a default that applies to all media streams, unless overridden by a media-level value. Whether present at the session or media-level, there MUST be an ice-pwd and ice-ufrag attribute for each media stream. If two media streams have identical ice-ufrag's, they MUST have identical ice-pwd's.

The ice-ufrag and ice-pwd attributes MUST be chosen randomly at the beginning of a session. The ice-ufrag attribute MUST contain at least 24 bits of randomness, and the ice-pwd attribute MUST contain at least 128 bits of randomness. This means that the ice-ufrag attribute will be at least 4 characters long, and the ice-pwd at least 22 characters long, since the grammar for these attributes allows for 6 bits of randomness per character. The attributes MAY be longer than 4 and 22 characters, respectively, of course, up to 256 characters. The upper limit allows for buffer sizing in implementations. Its large upper limit allows for increased amounts of randomness to be added over time.

#### 15.5. "ice-options" Attribute

The "ice-options" attribute is a session-level attribute. It contains a series of tokens that identify the options supported by the agent. Its grammar is:

```
ice-options      = "ice-options" ":" ice-option-tag
                  0*(SP ice-option-tag)
ice-option-tag   = 1*ice-char
```

#### 16. Setting Ta and RTO

During the gathering phase of ICE (Section 4.1.1) and while ICE is performing connectivity checks (Section 7), an agent sends STUN and TURN transactions. These transactions are paced at a rate of one every Ta milliseconds, and utilize a specific RTO. This section describes how the values of Ta and RTO are computed. This

computation depends on whether ICE is being used with a real-time media stream (such as RTP) or something else. When ICE is used for a stream with a known maximum bandwidth, the computation in Section 16.1 MAY be followed to rate-control the ICE exchanges. For all other streams, the computation in Section 16.2 MUST be followed.

### 16.1. RTP Media Streams

The values of RTO and Ta change during the lifetime of ICE processing. One set of values applies during the gathering phase, and the other, for connectivity checks.

The value of Ta SHOULD be configurable, and SHOULD have a default of:

For each media stream i:

$$Ta_i = (stun\_packet\_size / rtp\_packet\_size) * rtp\_ptime$$

$$Ta = \text{MAX} \left( 20\text{ms}, \frac{1}{\prod_{i=1}^k \left( \frac{1}{Ta_i} \right)} \right)$$

where k is the number of media streams. During the gathering phase, Ta is computed based on the number of media streams the agent has indicated in its offer or answer, and the RTP packet size and RTP ptime are those of the most preferred codec for each media stream. Once an offer and answer have been exchanged, the agent recomputes Ta to pace the connectivity checks. In that case, the value of Ta is based on the number of media streams that will actually be used in the session, and the RTP packet size and RTP ptime are those of the most preferred codec with which the agent will send.

In addition, the retransmission timer for the STUN transactions, RTO, defined in [RFC5389], SHOULD be configurable and during the gathering phase, SHOULD have a default of:

$$RTO = \text{MAX} (100\text{ms}, Ta * (\text{number of pairs}))$$

where the number of pairs refers to the number of pairs of candidates with STUN or TURN servers.

For connectivity checks, RTO SHOULD be configurable and SHOULD have a default of:

$$\text{RTO} = \text{MAX} (100\text{ms}, \text{Ta} * \text{N} * (\text{Num-Waiting} + \text{Num-In-Progress}))$$

where Num-Waiting is the number of checks in the check list in the Waiting state, and Num-In-Progress is the number of checks in the In-Progress state. Note that the RTO will be different for each transaction as the number of checks in the Waiting and In-Progress states change.

These formulas are aimed at causing STUN transactions to be paced at the same rate as media. This ensures that ICE will work properly under the same network conditions needed to support the media as well. See Appendix B.1 for additional discussion and motivations. Because of this pacing, it will take a certain amount of time to obtain all of the server reflexive and relayed candidates. Implementations should be aware of the time required to do this, and if the application requires a time budget, limit the number of candidates that are gathered.

The formulas result in a behavior whereby an agent will send its first packet for every single connectivity check before performing a retransmit. This can be seen in the formulas for the RTO (which represents the retransmit interval). Those formulas scale with N, the number of checks to be performed. As a result of this, ICE maintains a nicely constant rate, but becomes more sensitive to packet loss. The loss of the first single packet for any connectivity check is likely to cause that pair to take a long time to be validated, and instead, a lower-priority check (but one for which there was no packet loss) is much more likely to complete first. This results in ICE performing sub-optimally, choosing lower-priority pairs over higher-priority pairs. Implementors should be aware of this consequence, but still should utilize the timer values described here.

## 16.2. Non-RTP Sessions

In cases where ICE is used to establish some kind of session that is not real time, and has no fixed rate associated with it that is known to work on the network in which ICE is deployed, Ta and RTO revert to more conservative values. Ta SHOULD be configurable, SHOULD have a default of 500 ms, and MUST NOT be configurable to be less than 500 ms.

In addition, the retransmission timer for the STUN transactions, RTO, SHOULD be configurable and during the gathering phase, SHOULD have a default of:

$$RTO = \text{MAX} (500\text{ms}, T_a * (\text{number of pairs}))$$

where the number of pairs refers to the number of pairs of candidates with STUN or TURN servers.

For connectivity checks, RTO SHOULD be configurable and SHOULD have a default of:

$$RTO = \text{MAX} (500\text{ms}, T_a * N * (\text{Num-Waiting} + \text{Num-In-Progress}))$$

#### 17. Example

The example is based on the simplified topology of Figure 8.

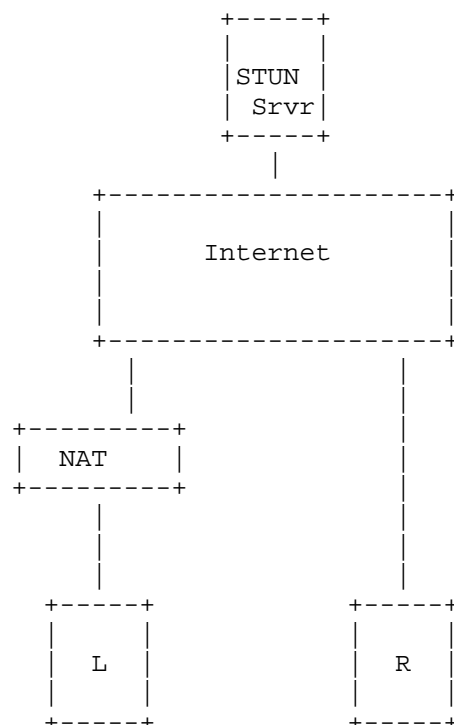

Figure 8: Example Topology

Two agents, L and R, are using ICE. Both are full-mode ICE implementations and use aggressive nomination when they are controlling. Both agents have a single IPv4 address. For agent L, it is 10.0.1.1 in private address space [RFC1918], and for agent R, 192.0.2.1 on the public Internet. Both are configured with the same STUN server (shown in this example for simplicity, although in

practice the agents do not need to use the same STUN server), which is listening for STUN Binding requests at an IP address of 192.0.2.2 and port 3478. TURN servers are not used in this example. Agent L is behind a NAT, and agent R is on the public Internet. The NAT has an endpoint independent mapping property and an address dependent filtering property. The public side of the NAT has an IP address of 192.0.2.3.

To facilitate understanding, transport addresses are listed using variables that have mnemonic names. The format of the name is entity-type-seqno, where entity refers to the entity whose IP address the transport address is on, and is one of "L", "R", "STUN", or "NAT". The type is either "PUB" for transport addresses that are public, and "PRIV" for transport addresses that are private. Finally, seq-no is a sequence number that is different for each transport address of the same type on a particular entity. Each variable has an IP address and port, denoted by varname.IP and varname.PORT, respectively, where varname is the name of the variable.

The STUN server has advertised transport address STUN-PUB-1 (which is 192.0.2.2:3478).

In the call flow itself, STUN messages are annotated with several attributes. The "S=" attribute indicates the source transport address of the message. The "D=" attribute indicates the destination transport address of the message. The "MA=" attribute is used in STUN Binding response messages and refers to the mapped address. "USE-CAND" implies the presence of the USE-CANDIDATE attribute.

The call flow examples omit STUN authentication operations and RTCP, and focus on RTP for a single media stream between two full implementations.

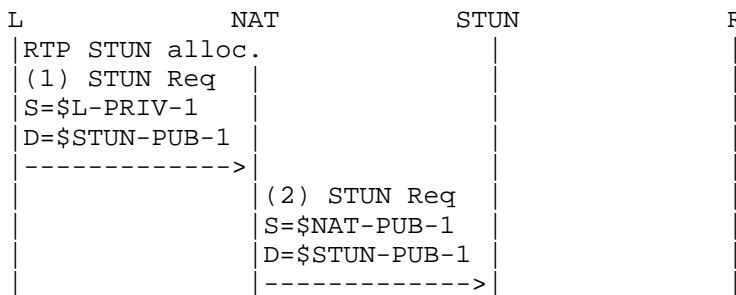



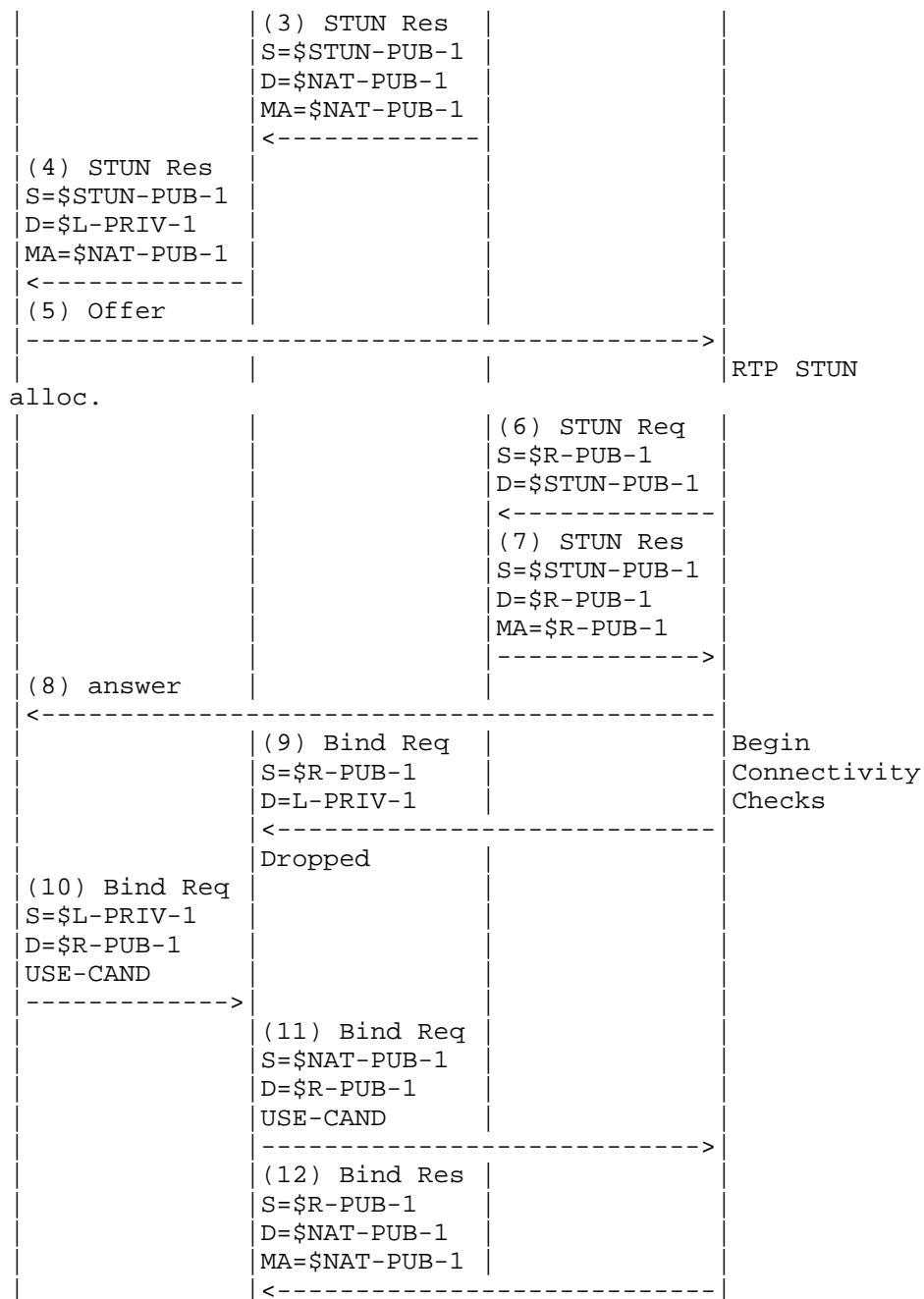

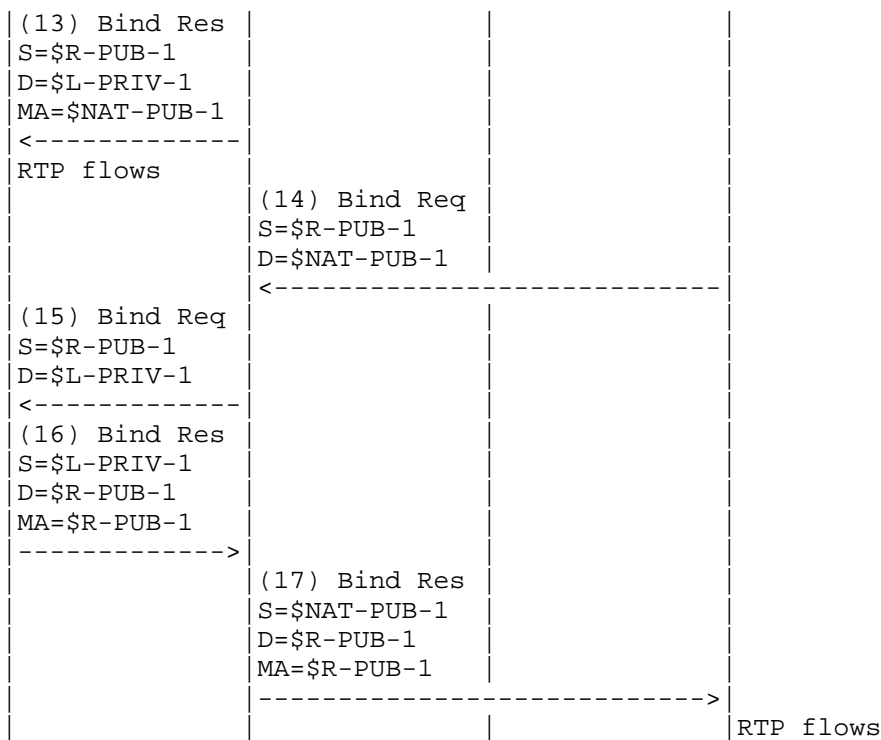

Figure 9: Example Flow

First, agent L obtains a host candidate from its local IP address (not shown), and from that, sends a STUN Binding request to the STUN server to get a server reflexive candidate (messages 1-4). Recall that the NAT has the address and port independent mapping property. Here, it creates a binding of NAT-PUB-1 for this UDP request, and this becomes the server reflexive candidate for RTP.

Agent L sets a type preference of 126 for the host candidate and 100 for the server reflexive. The local preference is 65535. Based on this, the priority of the host candidate is 2130706431 and for the server reflexive candidate is 1694498815. The host candidate is assigned a foundation of 1, and the server reflexive, a foundation of 2. It chooses its server reflexive candidate as the default candidate, and encodes it into the m and c lines. The resulting offer (message 5) looks like (lines folded for clarity):

```

v=0
o=jdoe 2890844526 2890842807 IN IP4 $L-PRIV-1.IP
s=
c=IN IP4 $NAT-PUB-1.IP
t=0 0
a=ice-pwd:asd88fgpdd777uzjYhagZg
a=ice-ufrag:8hhY
m=audio $NAT-PUB-1.PORT RTP/AVP 0
b=RS:0
b=RR:0
a=rtpmap:0 PCMU/8000
a=candidate:1 1 UDP 2130706431 $L-PRIV-1.IP $L-PRIV-1.PORT typ
host
a=candidate:2 1 UDP 1694498815 $NAT-PUB-1.IP $NAT-PUB-1.PORT typ
srflx raddr $L-PRIV-1.IP rport $L-PRIV-1.PORT

```

The offer, with the variables replaced with their values, will look like (lines folded for clarity):

```

v=0
o=jdoe 2890844526 2890842807 IN IP4 10.0.1.1
s=
c=IN IP4 192.0.2.3
t=0 0
a=ice-pwd:asd88fgpdd777uzjYhagZg
a=ice-ufrag:8hhY
m=audio 45664 RTP/AVP 0
b=RS:0
b=RR:0
a=rtpmap:0 PCMU/8000
a=candidate:1 1 UDP 2130706431 10.0.1.1 8998 typ host
a=candidate:2 1 UDP 1694498815 192.0.2.3 45664 typ srflx raddr
10.0.1.1 rport 8998

```

This offer is received at agent R. Agent R will obtain a host candidate, and from it, obtain a server reflexive candidate (messages 6-7). Since R is not behind a NAT, this candidate is identical to its host candidate, and they share the same base. It therefore discards this redundant candidate and ends up with a single host candidate. With identical type and local preferences as L, the priority for this candidate is 2130706431. It chooses a foundation of 1 for its single candidate. Its resulting answer looks like:

```

v=0
o=bob 2808844564 2808844564 IN IP4 $R-PUB-1.IP
s=
c=IN IP4 $R-PUB-1.IP
t=0 0
a=ice-pwd:YH75Fviy6338Vbrhr1p8Yh
a=ice-ufrag:9uB6
m=audio $R-PUB-1.PORT RTP/AVP 0
b=RS:0
b=RR:0
a=rtpmap:0 PCMU/8000
a=candidate:1 1 UDP 2130706431 $R-PUB-1.IP $R-PUB-1.PORT typ host

```

With the variables filled in:

```

v=0
o=bob 2808844564 2808844564 IN IP4 192.0.2.1
s=
c=IN IP4 192.0.2.1
t=0 0
a=ice-pwd:YH75Fviy6338Vbrhr1p8Yh
a=ice-ufrag:9uB6
m=audio 3478 RTP/AVP 0
b=RS:0
b=RR:0
a=rtpmap:0 PCMU/8000
a=candidate:1 1 UDP 2130706431 192.0.2.1 3478 typ host

```

Since neither side indicated that it is lite, the agent that sent the offer that began ICE processing (agent L) becomes the controlling agent.

Agents L and R both pair up the candidates. They both initially have two pairs. However, agent L will prune the pair containing its server reflexive candidate, resulting in just one. At agent L, this pair has a local candidate of \$L\_PRIV\_1 and remote candidate of \$R\_PUB\_1, and has a candidate pair priority of 4.57566E+18 (note that an implementation would represent this as a 64-bit integer so as not to lose precision). At agent R, there are two pairs. The highest priority has a local candidate of \$R\_PUB\_1 and remote candidate of \$L\_PRIV\_1 and has a priority of 4.57566E+18, and the second has a local candidate of \$R\_PUB\_1 and remote candidate of \$NAT\_PUB\_1 and priority 3.63891E+18.

Agent R begins its connectivity check (message 9) for the first pair (between the two host candidates). Since R is the controlled agent for this session, the check omits the USE-CANDIDATE attribute. The

host candidate from agent L is private and behind a NAT, and thus this check won't be successful, because the packet cannot be routed from R to L.

When agent L gets the answer, it performs its one and only connectivity check (messages 10-13). It implements the aggressive nomination algorithm, and thus includes a USE-CANDIDATE attribute in this check. Since the check succeeds, agent L creates a new pair, whose local candidate is from the mapped address in the Binding response (NAT-PUB-1 from message 13) and whose remote candidate is the destination of the request (R-PUB-1 from message 10). This is added to the valid list. In addition, it is marked as selected since the Binding request contained the USE-CANDIDATE attribute. Since there is a selected candidate in the Valid list for the one component of this media stream, ICE processing for this stream moves into the Completed state. Agent L can now send media if it so chooses.

Soon after receipt of the STUN Binding request from agent L (message 11), agent R will generate its triggered check. This check happens to match the next one on its check list -- from its host candidate to agent L's server reflexive candidate. This check (messages 14-17) will succeed. Consequently, agent R constructs a new candidate pair using the mapped address from the response as the local candidate (R-PUB-1) and the destination of the request (NAT-PUB-1) as the remote candidate. This pair is added to the Valid list for that media stream. Since the check was generated in the reverse direction of a check that contained the USE-CANDIDATE attribute, the candidate pair is marked as selected. Consequently, processing for this stream moves into the Completed state, and agent R can also send media.

## 18. Security Considerations

There are several types of attacks possible in an ICE system. This section considers these attacks and their countermeasures. These countermeasures include:

- o Using ICE in conjunction with secure signaling techniques, such as SIPS.
- o Limiting the total number of connectivity checks to 100, and optionally limiting the number of candidates they'll accept in an offer or answer.

### 18.1. Attacks on Connectivity Checks

An attacker might attempt to disrupt the STUN connectivity checks. Ultimately, all of these attacks fool an agent into thinking something incorrect about the results of the connectivity checks. The possible false conclusions an attacker can try and cause are:

**False Invalid:** An attacker can fool a pair of agents into thinking a candidate pair is invalid, when it isn't. This can be used to cause an agent to prefer a different candidate (such as one injected by the attacker) or to disrupt a call by forcing all candidates to fail.

**False Valid:** An attacker can fool a pair of agents into thinking a candidate pair is valid, when it isn't. This can cause an agent to proceed with a session, but then not be able to receive any media.

**False Peer Reflexive Candidate:** An attacker can cause an agent to discover a new peer reflexive candidate, when it shouldn't have. This can be used to redirect media streams to a Denial-of-Service (DoS) target or to the attacker, for eavesdropping or other purposes.

**False Valid on False Candidate:** An attacker has already convinced an agent that there is a candidate with an address that doesn't actually route to that agent (for example, by injecting a false peer reflexive candidate or false server reflexive candidate). It must then launch an attack that forces the agents to believe that this candidate is valid.

If an attacker can cause a false peer reflexive candidate or false valid on a false candidate, it can launch any of the attacks described in [RFC5389].

To force the false invalid result, the attacker has to wait for the connectivity check from one of the agents to be sent. When it is, the attacker needs to inject a fake response with an unrecoverable error response, such as a 400. However, since the candidate is, in fact, valid, the original request may reach the peer agent, and result in a success response. The attacker needs to force this packet or its response to be dropped, through a DoS attack, layer 2 network disruption, or other technique. If it doesn't do this, the success response will also reach the originator, alerting it to a possible attack. Fortunately, this attack is mitigated completely through the STUN short-term credential mechanism. The attacker needs to inject a fake response, and in order for this response to be processed, the attacker needs the password. If the offer/answer

signaling is secured, the attacker will not have the password and its response will be discarded.

Forcing the fake valid result works in a similar way. The agent needs to wait for the Binding request from each agent, and inject a fake success response. The attacker won't need to worry about disrupting the actual response since, if the candidate is not valid, it presumably wouldn't be received anyway. However, like the fake invalid attack, this attack is mitigated by the STUN short-term credential mechanism in conjunction with a secure offer/answer exchange.

Forcing the false peer reflexive candidate result can be done either with fake requests or responses, or with replays. We consider the fake requests and responses case first. It requires the attacker to send a Binding request to one agent with a source IP address and port for the false candidate. In addition, the attacker must wait for a Binding request from the other agent, and generate a fake response with a XOR-MAPPED-ADDRESS attribute containing the false candidate. Like the other attacks described here, this attack is mitigated by the STUN message integrity mechanisms and secure offer/answer exchanges.

Forcing the false peer reflexive candidate result with packet replays is different. The attacker waits until one of the agents sends a check. It intercepts this request, and replays it towards the other agent with a faked source IP address. It must also prevent the original request from reaching the remote agent, either by launching a DoS attack to cause the packet to be dropped, or forcing it to be dropped using layer 2 mechanisms. The replayed packet is received at the other agent, and accepted, since the integrity check passes (the integrity check cannot and does not cover the source IP address and port). It is then responded to. This response will contain a XOR-MAPPED-ADDRESS with the false candidate, and will be sent to that false candidate. The attacker must then receive it and relay it towards the originator.

The other agent will then initiate a connectivity check towards that false candidate. This validation needs to succeed. This requires the attacker to force a false valid on a false candidate. Injecting of fake requests or responses to achieve this goal is prevented using the integrity mechanisms of STUN and the offer/answer exchange. Thus, this attack can only be launched through replays. To do that, the attacker must intercept the check towards this false candidate, and replay it towards the other agent. Then, it must intercept the response and replay that back as well.

This attack is very hard to launch unless the attacker is identified by the fake candidate. This is because it requires the attacker to intercept and replay packets sent by two different hosts. If both agents are on different networks (for example, across the public Internet), this attack can be hard to coordinate, since it needs to occur against two different endpoints on different parts of the network at the same time.

If the attacker itself is identified by the fake candidate, the attack is easier to coordinate. However, if SRTP is used [RFC3711], the attacker will not be able to play the media packets, but will only be able to discard them, effectively disabling the media stream for the call. However, this attack requires the agent to disrupt packets in order to block the connectivity check from reaching the target. In that case, if the goal is to disrupt the media stream, it's much easier to just disrupt it with the same mechanism, rather than attack ICE.

### 18.2. Attacks on Server Reflexive Address Gathering

ICE endpoints make use of STUN Binding requests for gathering server reflexive candidates from a STUN server. These requests are not authenticated in any way. As a consequence, there are numerous techniques an attacker can employ to provide the client with a false server reflexive candidate:

- o An attacker can compromise the DNS, causing DNS queries to return a rogue STUN server address. That server can provide the client with fake server reflexive candidates. This attack is mitigated by DNS security, though DNS-SEC is not required to address it.
- o An attacker that can observe STUN messages (such as an attacker on a shared network segment, like WiFi) can inject a fake response that is valid and will be accepted by the client.
- o An attacker can compromise a STUN server by means of a virus, and cause it to send responses with incorrect mapped addresses.

A false mapped address learned by these attacks will be used as a server reflexive candidate in the ICE exchange. For this candidate to actually be used for media, the attacker must also attack the connectivity checks, and in particular, force a false valid on a false candidate. This attack is very hard to launch if the false address identifies a fourth party (neither the offerer, answerer, nor attacker), since it requires attacking the checks generated by each agent in the session, and is prevented by SRTP if it identifies the attacker themselves.



If the attacker elects not to attack the connectivity checks, the worst it can do is prevent the server reflexive candidate from being used. However, if the peer agent has at least one candidate that is reachable by the agent under attack, the STUN connectivity checks themselves will provide a peer reflexive candidate that can be used for the exchange of media. Peer reflexive candidates are generally preferred over server reflexive candidates. As such, an attack solely on the STUN address gathering will normally have no impact on a session at all.

### 18.3. Attacks on Relayed Candidate Gathering

An attacker might attempt to disrupt the gathering of relayed candidates, forcing the client to believe it has a false relayed candidate. Exchanges with the TURN server are authenticated using a long-term credential. Consequently, injection of fake responses or requests will not work. In addition, unlike Binding requests, Allocate requests are not susceptible to replay attacks with modified source IP addresses and ports, since the source IP address and port are not utilized to provide the client with its relayed candidate.

However, TURN servers are susceptible to DNS attacks, or to viruses aimed at the TURN server, for purposes of turning it into a zombie or rogue server. These attacks can be mitigated by DNS-SEC and through good box and software security on TURN servers.

Even if an attacker has caused the client to believe in a false relayed candidate, the connectivity checks cause such a candidate to be used only if they succeed. Thus, an attacker must launch a false valid on a false candidate, per above, which is a very difficult attack to coordinate.

### 18.4. Attacks on the Offer/Answer Exchanges

An attacker that can modify or disrupt the offer/answer exchanges themselves can readily launch a variety of attacks with ICE. They could direct media to a target of a DoS attack, they could insert themselves into the media stream, and so on. These are similar to the general security considerations for offer/answer exchanges, and the security considerations in RFC 3264 [RFC3264] apply. These require techniques for message integrity and encryption for offers and answers, which are satisfied by the SIPS mechanism [RFC3261] when SIP is used. As such, the usage of SIPS with ICE is RECOMMENDED.

## 18.5. Insider Attacks

In addition to attacks where the attacker is a third party trying to insert fake offers, answers, or stun messages, there are several attacks possible with ICE when the attacker is an authenticated and valid participant in the ICE exchange.

### 18.5.1. The Voice Hammer Attack

The voice hammer attack is an amplification attack. In this attack, the attacker initiates sessions to other agents, and maliciously includes the IP address and port of a DoS target as the destination for media traffic signaled in the SDP. This causes substantial amplification; a single offer/answer exchange can create a continuing flood of media packets, possibly at high rates (consider video sources). This attack is not specific to ICE, but ICE can help provide remediation.

Specifically, if ICE is used, the agent receiving the malicious SDP will first perform connectivity checks to the target of media before sending media there. If this target is a third-party host, the checks will not succeed, and media is never sent.

Unfortunately, ICE doesn't help if its not used, in which case an attacker could simply send the offer without the ICE parameters. However, in environments where the set of clients is known, and is limited to ones that support ICE, the server can reject any offers or answers that don't indicate ICE support.

### 18.5.2. STUN Amplification Attack

The STUN amplification attack is similar to the voice hammer. However, instead of voice packets being directed to the target, STUN connectivity checks are directed to the target. The attacker sends an offer with a large number of candidates, say, 50. The answerer receives the offer, and starts its checks, which are directed at the target, and consequently, never generate a response. The answerer will start a new connectivity check every  $T_a$  ms (say,  $T_a=20$ ms). However, the retransmission timers are set to a large number due to the large number of candidates. As a consequence, packets will be sent at an interval of one every  $T_a$  milliseconds, and then with increasing intervals after that. Thus, STUN will not send packets at a rate faster than media would be sent, and the STUN packets persist only briefly, until ICE fails for the session. Nonetheless, this is an amplification mechanism.

It is impossible to eliminate the amplification, but the volume can be reduced through a variety of heuristics. Agents SHOULD limit the

total number of connectivity checks they perform to 100. Additionally, agents MAY limit the number of candidates they'll accept in an offer or answer.

Frequently, protocols that wish to avoid these kinds of attacks force the initiator to wait for a response prior to sending the next message. However, in the case of ICE, this is not possible. It is not possible to differentiate the following two cases:

- o There was no response because the initiator is being used to launch a DoS attack against an unsuspecting target that will not respond.
- o There was no response because the IP address and port are not reachable by the initiator.

In the second case, another check should be sent at the next opportunity, while in the former case, no further checks should be sent.

#### 18.6. Interactions with Application Layer Gateways and SIP

Application Layer Gateways (ALGs) are functions present in a NAT device that inspect the contents of packets and modify them, in order to facilitate NAT traversal for application protocols. Session Border Controllers (SBCs) are close cousins of ALGs, but are less transparent since they actually exist as application layer SIP intermediaries. ICE has interactions with SBCs and ALGs.

If an ALG is SIP aware but not ICE aware, ICE will work through it as long as the ALG correctly modifies the SDP. A correct ALG implementation behaves as follows:

- o The ALG does not modify the m and c lines or the rtcp attribute if they contain external addresses.
- o If the m and c lines contain internal addresses, the modification depends on the state of the ALG:

If the ALG already has a binding established that maps an external port to an internal IP address and port matching the values in the m and c lines or rtcp attribute, the ALG uses that binding instead of creating a new one.

If the ALG does not already have a binding, it creates a new one and modifies the SDP, rewriting the m and c lines and rtcp attribute.

Unfortunately, many ALGs are known to work poorly in these corner cases. ICE does not try to work around broken ALGs, as this is outside the scope of its functionality. ICE can help diagnose these conditions, which often show up as a mismatch between the set of candidates and the m and c lines and rtcp attributes. The ice-mismatch attribute is used for this purpose.

ICE works best through ALGs when the signaling is run over TLS. This prevents the ALG from manipulating the SDP messages and interfering with ICE operation. Implementations that are expected to be deployed behind ALGs SHOULD provide for TLS transport of the SDP.

If an SBC is SIP aware but not ICE aware, the result depends on the behavior of the SBC. If it is acting as a proper Back-to-Back User Agent (B2BUA), the SBC will remove any SDP attributes it doesn't understand, including the ICE attributes. Consequently, the call will appear to both endpoints as if the other side doesn't support ICE. This will result in ICE being disabled, and media flowing through the SBC, if the SBC has requested it. If, however, the SBC passes the ICE attributes without modification, yet modifies the default destination for media (contained in the m and c lines and rtcp attribute), this will be detected as an ICE mismatch, and ICE processing is aborted for the call. It is outside of the scope of ICE for it to act as a tool for "working around" SBCs. If one is present, ICE will not be used and the SBC techniques take precedence.

## 19. STUN Extensions

### 19.1. New Attributes

This specification defines four new attributes, PRIORITY, USE-CANDIDATE, ICE-CONTROLLED, and ICE-CONTROLLING.

The PRIORITY attribute indicates the priority that is to be associated with a peer reflexive candidate, should one be discovered by this check. It is a 32-bit unsigned integer, and has an attribute value of 0x0024.

The USE-CANDIDATE attribute indicates that the candidate pair resulting from this check should be used for transmission of media. The attribute has no content (the Length field of the attribute is zero); it serves as a flag. It has an attribute value of 0x0025.

The ICE-CONTROLLED attribute is present in a Binding request and indicates that the client believes it is currently in the controlled role. The content of the attribute is a 64-bit unsigned integer in network byte order, which contains a random number used for tie-breaking of role conflicts.

The ICE-CONTROLLING attribute is present in a Binding request and indicates that the client believes it is currently in the controlling role. The content of the attribute is a 64-bit unsigned integer in network byte order, which contains a random number used for tie-breaking of role conflicts.

## 19.2. New Error Response Codes

This specification defines a single error response code:

487 (Role Conflict): The Binding request contained either the ICE-CONTROLLING or ICE-CONTROLLED attribute, indicating a role that conflicted with the server. The server ran a tie-breaker based on the tie-breaker value in the request and determined that the client needs to switch roles.

## 20. Operational Considerations

This section discusses issues relevant to network operators looking to deploy ICE.

### 20.1. NAT and Firewall Types

ICE was designed to work with existing NAT and firewall equipment. Consequently, it is not necessary to replace or reconfigure existing firewall and NAT equipment in order to facilitate deployment of ICE. Indeed, ICE was developed to be deployed in environments where the Voice over IP (VoIP) operator has no control over the IP network infrastructure, including firewalls and NAT.

That said, ICE works best in environments where the NAT devices are "behave" compliant, meeting the recommendations defined in [RFC4787] and [RFC5766]. In networks with behave-compliant NAT, ICE will work without the need for a TURN server, thus improving voice quality, decreasing call setup times, and reducing the bandwidth demands on the network operator.

### 20.2. Bandwidth Requirements

Deployment of ICE can have several interactions with available network capacity that operators should take into consideration.

#### 20.2.1. STUN and TURN Server Capacity Planning

First and foremost, ICE makes use of TURN and STUN servers, which would typically be located in the network operator's data centers. The STUN servers require relatively little bandwidth. For each component of each media stream, there will be one or more STUN

transactions from each client to the STUN server. In a basic voice-only IPv4 VoIP deployment, there will be four transactions per call (one for RTP and one for RTCP, for both caller and callee). Each transaction is a single request and a single response, the former being 20 bytes long, and the latter, 28. Consequently, if a system has  $N$  users, and each makes four calls in a busy hour, this would require  $N*1.7$ bps. For one million users, this is 1.7 Mbps, a very small number (relatively speaking).

TURN traffic is more substantial. The TURN server will see traffic volume equal to the STUN volume (indeed, if TURN servers are deployed, there is no need for a separate STUN server), in addition to the traffic for the actual media traffic. The amount of calls requiring TURN for media relay is highly dependent on network topologies, and can and will vary over time. In a network with 100% behave-compliant NAT, it is exactly zero. At time of writing, large-scale consumer deployments were seeing between 5 and 10 percent of calls requiring TURN servers. Considering a voice-only deployment using G.711 (so 80 kbps in each direction), with .2 erlangs during the busy hour, this is  $N*3.2$  kbps. For a population of one million users, this is 3.2 Gbps, assuming a 10% usage of TURN servers.

#### 20.2.2. Gathering and Connectivity Checks

The process of gathering of candidates and performing of connectivity checks can be bandwidth intensive. ICE has been designed to pace both of these processes. The gathering phase and the connectivity check phase are meant to generate traffic at roughly the same bandwidth as the media traffic itself. This was done to ensure that, if a network is designed to support multimedia traffic of a certain type (voice, video, or just text), it will have sufficient capacity to support the ICE checks for that media. Of course, the ICE checks will cause a marginal increase in the total utilization; however, this will typically be an extremely small increase.

Congestion due to the gathering and check phases has proven to be a problem in deployments that did not utilize pacing. Typically, access links became congested as the endpoints flooded the network with checks as fast as they can send them. Consequently, network operators should make sure that their ICE implementations support the pacing feature. Though this pacing does increase call setup times, it makes ICE network friendly and easier to deploy.

#### 20.2.3. Keepalives

STUN keepalives (in the form of STUN Binding Indications) are sent in the middle of a media session. However, they are sent only in the absence of actual media traffic. In deployments that are not

utilizing Voice Activity Detection (VAD), the keepalives are never used and there is no increase in bandwidth usage. When VAD is being used, keepalives will be sent during silence periods. This involves a single packet every 15-20 seconds, far less than the packet every 20-30 ms that is sent when there is voice. Therefore, keepalives don't have any real impact on capacity planning.

### 20.3. ICE and ICE-lite

Deployments utilizing a mix of ICE and ICE-lite interoperate perfectly. They have been explicitly designed to do so, without loss of function.

However, ICE-lite can only be deployed in limited use cases. Those cases, and the caveats involved in doing so, are documented in Appendix A.

### 20.4. Troubleshooting and Performance Management

ICE utilizes end-to-end connectivity checks, and places much of the processing in the endpoints. This introduces a challenge to the network operator -- how can they troubleshoot ICE deployments? How can they know how ICE is performing?

ICE has built-in features to help deal with these problems. SIP servers on the signaling path, typically deployed in the data centers of the network operator, will see the contents of the offer/answer exchanges that convey the ICE parameters. These parameters include the type of each candidate (host, server reflexive, or relayed), along with their related addresses. Once ICE processing has completed, an updated offer/answer exchange takes place, signaling the selected address (and its type). This updated re-INVITE is performed exactly for the purposes of educating network equipment (such as a diagnostic tool attached to a SIP server) about the results of ICE processing.

As a consequence, through the logs generated by the SIP server, a network operator can observe what types of candidates are being used for each call, and what address was selected by ICE. This is the primary information that helps evaluate how ICE is performing.

### 20.5. Endpoint Configuration

ICE relies on several pieces of data being configured into the endpoints. This configuration data includes timers, credentials for TURN servers, and hostnames for STUN and TURN servers. ICE itself does not provide a mechanism for this configuration. Instead, it is assumed that this information is attached to whatever mechanism is

used to configure all of the other parameters in the endpoint. For SIP phones, standard solutions such as the configuration framework [SIP-UA-FRMWK] have been defined.

## 21. IANA Considerations

This specification registers new SDP attributes, four new STUN attributes, and one new STUN error response.

### 21.1. SDP Attributes

This specification defines seven new SDP attributes per the procedures of Section 8.2.4 of [RFC4566]. The required information for the registrations is included here.

#### 21.1.1. candidate Attribute

Contact Name: Jonathan Rosenberg, jdrosen@jdrosen.net.

Attribute Name: candidate

Long Form: candidate

Type of Attribute: media-level

Charset Considerations: The attribute is not subject to the charset attribute.

Purpose: This attribute is used with Interactive Connectivity Establishment (ICE), and provides one of many possible candidate addresses for communication. These addresses are validated with an end-to-end connectivity check using Session Traversal Utilities for NAT (STUN).

Appropriate Values: See Section 15 of RFC 5245.

#### 21.1.2. remote-candidates Attribute

Contact Name: Jonathan Rosenberg, jdrosen@jdrosen.net.

Attribute Name: remote-candidates

Long Form: remote-candidates

Type of Attribute: media-level

Charset Considerations: The attribute is not subject to the charset attribute.



**Purpose:** This attribute is used with Interactive Connectivity Establishment (ICE), and provides the identity of the remote candidates that the offerer wishes the answerer to use in its answer.

**Appropriate Values:** See Section 15 of RFC 5245.

#### 21.1.3. ice-lite Attribute

**Contact Name:** Jonathan Rosenberg, jdrosen@jdrosen.net.

**Attribute Name:** ice-lite

**Long Form:** ice-lite

**Type of Attribute:** session-level

**Charset Considerations:** The attribute is not subject to the charset attribute.

**Purpose:** This attribute is used with Interactive Connectivity Establishment (ICE), and indicates that an agent has the minimum functionality required to support ICE inter-operation with a peer that has a full implementation.

**Appropriate Values:** See Section 15 of RFC 5245.

#### 21.1.4. ice-mismatch Attribute

**Contact Name:** Jonathan Rosenberg, jdrosen@jdrosen.net.

**Attribute Name:** ice-mismatch

**Long Form:** ice-mismatch

**Type of Attribute:** session-level

**Charset Considerations:** The attribute is not subject to the charset attribute.

**Purpose:** This attribute is used with Interactive Connectivity Establishment (ICE), and indicates that an agent is ICE capable, but did not proceed with ICE due to a mismatch of candidates with the default destination for media signaled in the SDP.

**Appropriate Values:** See Section 15 of RFC 5245.

#### 21.1.5. ice-pwd Attribute

Contact Name: Jonathan Rosenberg, jdrosen@jdrosen.net.

Attribute Name: ice-pwd

Long Form: ice-pwd

Type of Attribute: session- or media-level

Charset Considerations: The attribute is not subject to the charset attribute.

Purpose: This attribute is used with Interactive Connectivity Establishment (ICE), and provides the password used to protect STUN connectivity checks.

Appropriate Values: See Section 15 of RFC 5245.

#### 21.1.6. ice-ufrag Attribute

Contact Name: Jonathan Rosenberg, jdrosen@jdrosen.net.

Attribute Name: ice-ufrag

Long Form: ice-ufrag

Type of Attribute: session- or media-level

Charset Considerations: The attribute is not subject to the charset attribute.

Purpose: This attribute is used with Interactive Connectivity Establishment (ICE), and provides the fragments used to construct the username in STUN connectivity checks.

Appropriate Values: See Section 15 of RFC 5245.

#### 21.1.7. ice-options Attribute

Contact Name: Jonathan Rosenberg, jdrosen@jdrosen.net.

Attribute Name: ice-options

Long Form: ice-options

Type of Attribute: session-level

Charset Considerations: The attribute is not subject to the charset attribute.

Purpose: This attribute is used with Interactive Connectivity Establishment (ICE), and indicates the ICE options or extensions used by the agent.

Appropriate Values: See Section 15 of RFC 5245.

## 21.2. STUN Attributes

This section registers four new STUN attributes per the procedures in [RFC5389].

0x0024 PRIORITY  
0x0025 USE-CANDIDATE  
0x8029 ICE-CONTROLLED  
0x802A ICE-CONTROLLING

## 21.3. STUN Error Responses

This section registers one new STUN error response code per the procedures in [RFC5389].

487 Role Conflict: The client asserted an ICE role (controlling or controlled) that is in conflict with the role of the server.

## 22. IAB Considerations

The IAB has studied the problem of "Unilateral Self-Address Fixing", which is the general process by which a agent attempts to determine its address in another realm on the other side of a NAT through a collaborative protocol reflection mechanism [RFC3424]. ICE is an example of a protocol that performs this type of function. Interestingly, the process for ICE is not unilateral, but bilateral, and the difference has a significant impact on the issues raised by IAB. Indeed, ICE can be considered a B-SAF (Bilateral Self-Address Fixing) protocol, rather than an UNSAF protocol. Regardless, the IAB has mandated that any protocols developed for this purpose document a specific set of considerations. This section meets those requirements.

## 22.1. Problem Definition

>From RFC 3424, any UNSAF proposal must provide:

Precise definition of a specific, limited-scope problem that is to be solved with the UNSAF proposal. A short-term fix should not be generalized to solve other problems; this is why "short-term fixes usually aren't".

The specific problems being solved by ICE are:

Provide a means for two peers to determine the set of transport addresses that can be used for communication.

Provide a means for a agent to determine an address that is reachable by another peer with which it wishes to communicate.

## 22.2. Exit Strategy

>From RFC 3424, any UNSAF proposal must provide:

Description of an exit strategy/transition plan. The better short-term fixes are the ones that will naturally see less and less use as the appropriate technology is deployed.

ICE itself doesn't easily get phased out. However, it is useful even in a globally connected Internet, to serve as a means for detecting whether a router failure has temporarily disrupted connectivity, for example. ICE also helps prevent certain security attacks that have nothing to do with NAT. However, what ICE does is help phase out other UNSAF mechanisms. ICE effectively selects amongst those mechanisms, prioritizing ones that are better, and deprioritizing ones that are worse. Local IPv6 addresses can be preferred. As NATs begin to dissipate as IPv6 is introduced, server reflexive and relayed candidates (both forms of UNSAF addresses) simply never get used, because higher-priority connectivity exists to the native host candidates. Therefore, the servers get used less and less, and can eventually be remove when their usage goes to zero.

Indeed, ICE can assist in the transition from IPv4 to IPv6. It can be used to determine whether to use IPv6 or IPv4 when two dual-stack hosts communicate with SIP (IPv6 gets used). It can also allow a network with both 6to4 and native v6 connectivity to determine which address to use when communicating with a peer.

### 22.3. Brittleness Introduced by ICE

>From RFC 3424, any UNSAF proposal must provide:

Discussion of specific issues that may render systems more "brittle". For example, approaches that involve using data at multiple network layers create more dependencies, increase debugging challenges, and make it harder to transition.

ICE actually removes brittleness from existing UNSAF mechanisms. In particular, classic STUN (as described in RFC 3489 [RFC3489]) has several points of brittleness. One of them is the discovery process that requires an agent to try to classify the type of NAT it is behind. This process is error-prone. With ICE, that discovery process is simply not used. Rather than unilaterally assessing the validity of the address, its validity is dynamically determined by measuring connectivity to a peer. The process of determining connectivity is very robust.

Another point of brittleness in classic STUN and any other unilateral mechanism is its absolute reliance on an additional server. ICE makes use of a server for allocating unilateral addresses, but allows agents to directly connect if possible. Therefore, in some cases, the failure of a STUN server would still allow for a call to progress when ICE is used.

Another point of brittleness in classic STUN is that it assumes that the STUN server is on the public Internet. Interestingly, with ICE, that is not necessary. There can be a multitude of STUN servers in a variety of address realms. ICE will discover the one that has provided a usable address.

The most troubling point of brittleness in classic STUN is that it doesn't work in all network topologies. In cases where there is a shared NAT between each agent and the STUN server, traditional STUN may not work. With ICE, that restriction is removed.

Classic STUN also introduces some security considerations. Fortunately, those security considerations are also mitigated by ICE.

Consequently, ICE serves to repair the brittleness introduced in classic STUN, and does not introduce any additional brittleness into the system.

The penalty of these improvements is that ICE increases session establishment times.

#### 22.4. Requirements for a Long-Term Solution

From RFC 3424, any UNSAF proposal must provide:

... requirements for longer term, sound technical solutions -- contribute to the process of finding the right longer term solution.

Our conclusions from RFC 3489 remain unchanged. However, we feel ICE actually helps because we believe it can be part of the long-term solution.

#### 22.5. Issues with Existing NAPT Boxes

From RFC 3424, any UNSAF proposal must provide:

Discussion of the impact of the noted practical issues with existing, deployed NA[P]Ts and experience reports.

A number of NAT boxes are now being deployed into the market that try to provide "generic" ALG functionality. These generic ALGs hunt for IP addresses, either in text or binary form within a packet, and rewrite them if they match a binding. This interferes with classic STUN. However, the update to STUN [RFC5389] uses an encoding that hides these binary addresses from generic ALGs.

Existing NAPT boxes have non-deterministic and typically short expiration times for UDP-based bindings. This requires implementations to send periodic keepalives to maintain those bindings. ICE uses a default of 15 s, which is a very conservative estimate. Eventually, over time, as NAT boxes become compliant to behave [RFC4787], this minimum keepalive will become deterministic and well-known, and the ICE timers can be adjusted. Having a way to discover and control the minimum keepalive interval would be far better still.

#### 23. Acknowledgements

The authors would like to thank Dan Wing, Eric Rescorla, Flemming Andreasen, Rohan Mahy, Dean Willis, Eric Cooper, Jason Fischl, Douglas Otis, Tim Moore, Jean-Francois Mule, Kevin Johns, Jonathan Lennox, and Francois Audet for their comments and input. A special thanks goes to Bill May, who suggested several of the concepts in this specification, Philip Matthews, who suggested many of the key performance optimizations in this specification, Eric Rescorla, who drafted the text in the introduction, and Magnus Westerlund, for doing several detailed reviews on the various revisions of this specification.

## 24. References

### 24.1. Normative References

- [RFC2119] Bradner, S., "Key words for use in RFCs to Indicate Requirement Levels", BCP 14, RFC 2119, March 1997.
- [RFC3605] Huitema, C., "Real Time Control Protocol (RTCP) attribute in Session Description Protocol (SDP)", RFC 3605, October 2003.
- [RFC3261] Rosenberg, J., Schulzrinne, H., Camarillo, G., Johnston, A., Peterson, J., Sparks, R., Handley, M., and E. Schooler, "SIP: Session Initiation Protocol", RFC 3261, June 2002.
- [RFC3264] Rosenberg, J. and H. Schulzrinne, "An Offer/Answer Model with Session Description Protocol (SDP)", RFC 3264, June 2002.
- [RFC3556] Casner, S., "Session Description Protocol (SDP) Bandwidth Modifiers for RTP Control Protocol (RTCP) Bandwidth", RFC 3556, July 2003.
- [RFC3312] Camarillo, G., Marshall, W., and J. Rosenberg, "Integration of Resource Management and Session Initiation Protocol (SIP)", RFC 3312, October 2002.
- [RFC4032] Camarillo, G. and P. Kyzivat, "Update to the Session Initiation Protocol (SIP) Preconditions Framework", RFC 4032, March 2005.
- [RFC3262] Rosenberg, J. and H. Schulzrinne, "Reliability of Provisional Responses in Session Initiation Protocol (SIP)", RFC 3262, June 2002.
- [RFC4566] Handley, M., Jacobson, V., and C. Perkins, "SDP: Session Description Protocol", RFC 4566, July 2006.
- [RFC4091] Camarillo, G. and J. Rosenberg, "The Alternative Network Address Types (ANAT) Semantics for the Session Description Protocol (SDP) Grouping Framework", RFC 4091, June 2005.
- [RFC4092] Camarillo, G. and J. Rosenberg, "Usage of the Session Description Protocol (SDP) Alternative Network Address Types (ANAT) Semantics in the Session Initiation Protocol (SIP)", RFC 4092, June 2005.

- [RFC3484] Draves, R., "Default Address Selection for Internet Protocol version 6 (IPv6)", RFC 3484, February 2003.
- [RFC5234] Crocker, D., Ed., and P. Overell, "Augmented BNF for Syntax Specifications: ABNF", STD 68, RFC 5234, January 2008.
- [RFC5389] Rosenberg, J., Mahy, R., Matthews, P., and D. Wing, "Session Traversal Utilities for NAT (STUN)", RFC 5389, October 2008.
- [RFC5766] Mahy, R., Matthews, P., and J. Rosenberg, "Traversal Using Relays around NAT (TURN): Relay Extensions to Session Traversal Utilities for NAT (STUN)", RFC 5766, April 2010.
- [RFC5768] Rosenberg, J., "Indicating Support for Interactive Connectivity Establishment (ICE) in the Session Initiation Protocol (SIP)", RFC 5768, April 2010.

#### 24.2. Informative References

- [RFC3489] Rosenberg, J., Weinberger, J., Huitema, C., and R. Mahy, "STUN - Simple Traversal of User Datagram Protocol (UDP) Through Network Address Translators (NATs)", RFC 3489, March 2003.
- [RFC3235] Senie, D., "Network Address Translator (NAT)-Friendly Application Design Guidelines", RFC 3235, January 2002.
- [RFC3303] Srisuresh, P., Kuthan, J., Rosenberg, J., Molitor, A., and A. Rayhan, "Middlebox communication architecture and framework", RFC 3303, August 2002.
- [RFC3725] Rosenberg, J., Peterson, J., Schulzrinne, H., and G. Camarillo, "Best Current Practices for Third Party Call Control (3pcc) in the Session Initiation Protocol (SIP)", BCP 85, RFC 3725, April 2004.
- [RFC3102] Borella, M., Lo, J., Grabelsky, D., and G. Montenegro, "Realm Specific IP: Framework", RFC 3102, October 2001.
- [RFC3103] Borella, M., Grabelsky, D., Lo, J., and K. Taniguchi, "Realm Specific IP: Protocol Specification", RFC 3103, October 2001.
- [RFC3424] Daigle, L. and IAB, "IAB Considerations for UNilateral Self-Address Fixing (UNSAF) Across Network Address Translation", RFC 3424, November 2002.



- [RFC3550] Schulzrinne, H., Casner, S., Frederick, R., and V. Jacobson, "RTP: A Transport Protocol for Real-Time Applications", STD 64, RFC 3550, July 2003.
- [RFC3711] Baugher, M., McGrew, D., Naslund, M., Carrara, E., and K. Norrman, "The Secure Real-time Transport Protocol (SRTP)", RFC 3711, March 2004.
- [RFC3056] Carpenter, B. and K. Moore, "Connection of IPv6 Domains via IPv4 Clouds", RFC 3056, February 2001.
- [RFC3389] Zopf, R., "Real-time Transport Protocol (RTP) Payload for Comfort Noise (CN)", RFC 3389, September 2002.
- [RFC3960] Camarillo, G. and H. Schulzrinne, "Early Media and Ringing Tone Generation in the Session Initiation Protocol (SIP)", RFC 3960, December 2004.
- [RFC2475] Blake, S., Black, D., Carlson, M., Davies, E., Wang, Z., and W. Weiss, "An Architecture for Differentiated Services", RFC 2475, December 1998.
- [RFC1918] Rekhter, Y., Moskowitz, R., Karrenberg, D., Groot, G., and E. Lear, "Address Allocation for Private Internets", BCP 5, RFC 1918, February 1996.
- [RFC4787] Audet, F. and C. Jennings, "Network Address Translation (NAT) Behavioral Requirements for Unicast UDP", BCP 127, RFC 4787, January 2007.
- [SDP-PRECON]  
Andreasen, F., Camarillo, G., Oran, D., and D. Wing, "Connectivity Preconditions for Session Description Protocol Media Streams", Work in Progress, March 2010.
- [NO-OP-RTP]  
Andreasen, F., Oran, D., and D. Wing, "A No-Op Payload Format for RTP", Work in Progress, May 2007.
- [RFC5761] Perkins, C. and M. Westerlund, "Multiplexing RTP Data and Control Packets on a Single Port", RFC 5761, April 2010.
- [RFC4340] Kohler, E., Handley, M., and S. Floyd, "Datagram Congestion Control Protocol (DCCP)", RFC 4340, March 2006.
- [RFC4103] Hellstrom, G. and P. Jones, "RTP Payload for Text Conversation", RFC 4103, June 2005.

- [RFC5626] Jennings, C., Mahy, R., and F. Audet, "Managing Client-Initiated Connections in the Session Initiation Protocol (SIP)", RFC 5626, October 2009.
- [RFC5382] Guha, S., Biswas, K., Ford, B., Sivakumar, S., and P. Srisuresh, "NAT Behavioral Requirements for TCP", BCP 142, RFC 5382, October 2008.
- [SIP-UA-FRMWK] Petrie, D. and S. Channabasappa, Ed., "A Framework for Session Initiation Protocol User Agent Profile Delivery", Work in Progress, February 2010.
- [ICE-TCP] Perreault, S., Ed. and J. Rosenberg, "TCP Candidates with Interactive Connectivity Establishment (ICE)", Work in Progress, October 2009.

## Appendix A. Lite and Full Implementations

ICE allows for two types of implementations. A full implementation supports the controlling and controlled roles in a session, and can also perform address gathering. In contrast, a lite implementation is a minimalist implementation that does little but respond to STUN checks.

Because ICE requires both endpoints to support it in order to bring benefits to either endpoint, incremental deployment of ICE in a network is more complicated. Many sessions involve an endpoint that is, by itself, not behind a NAT and not one that would worry about NAT traversal. A very common case is to have one endpoint that requires NAT traversal (such as a VoIP hard phone or soft phone) make a call to one of these devices. Even if the phone supports a full ICE implementation, ICE won't be used at all if the other device doesn't support it. The lite implementation allows for a low-cost entry point for these devices. Once they support the lite implementation, full implementations can connect to them and get the full benefits of ICE.

Consequently, a lite implementation is only appropriate for devices that will *\*always\** be connected to the public Internet and have a public IP address at which it can receive packets from any correspondent. ICE will not function when a lite implementation is placed behind a NAT.

ICE allows a lite implementation to have a single IPv4 host candidate and several IPv6 addresses. In that case, candidate pairs are selected by the controlling agent using a static algorithm, such as the one in RFC 3484, which is recommended by this specification. However, static mechanisms for address selection are always prone to error, since they cannot ever reflect the actual topology and can never provide actual guarantees on connectivity. They are always heuristics. Consequently, if an agent is implementing ICE just to select between its IPv4 and IPv6 addresses, and none of its IP addresses are behind NAT, usage of full ICE is still RECOMMENDED in order to provide the most robust form of address selection possible.

It is important to note that the lite implementation was added to this specification to provide a stepping stone to full implementation. Even for devices that are always connected to the public Internet with just a single IPv4 address, a full implementation is preferable if achievable. A full implementation will reduce call setup times, since ICE's aggressive mode can be used. Full implementations also obtain the security benefits of ICE unrelated to NAT traversal; in particular, the voice hammer attack described in Section 18 is prevented only for full implementations,

not lite. Finally, it is often the case that a device that finds itself with a public address today will be placed in a network tomorrow where it will be behind a NAT. It is difficult to definitively know, over the lifetime of a device or product, that it will always be used on the public Internet. Full implementation provides assurance that communications will always work.

## Appendix B. Design Motivations

ICE contains a number of normative behaviors that may themselves be simple, but derive from complicated or non-obvious thinking or use cases that merit further discussion. Since these design motivations are not necessary to understand for purposes of implementation, they are discussed here in an appendix to the specification. This section is non-normative.

### B.1. Pacing of STUN Transactions

STUN transactions used to gather candidates and to verify connectivity are paced out at an approximate rate of one new transaction every  $T_a$  milliseconds. Each transaction, in turn, has a retransmission timer  $RTO$  that is a function of  $T_a$  as well. Why are these transactions paced, and why are these formulas used?

Sending of these STUN requests will often have the effect of creating bindings on NAT devices between the client and the STUN servers. Experience has shown that many NAT devices have upper limits on the rate at which they will create new bindings. Experiments have shown that once every 20 ms is well supported, but not much lower than that. This is why  $T_a$  has a lower bound of 20 ms. Furthermore, transmission of these packets on the network makes use of bandwidth and needs to be rate limited by the agent. Deployments based on earlier draft versions of this document tended to overload rate-constrained access links and perform poorly overall, in addition to negatively impacting the network. As a consequence, the pacing ensures that the NAT device does not get overloaded and that traffic is kept at a reasonable rate.

The definition of a "reasonable" rate is that STUN should not use more bandwidth than the RTP itself will use, once media starts flowing. The formula for  $T_a$  is designed so that, if a STUN packet were sent every  $T_a$  seconds, it would consume the same amount of bandwidth as RTP packets, summed across all media streams. Of course, STUN has retransmits, and the desire is to pace those as well. For this reason,  $RTO$  is set such that the first retransmit on the first transaction happens just as the first STUN request on the last transaction occurs. Pictorially:



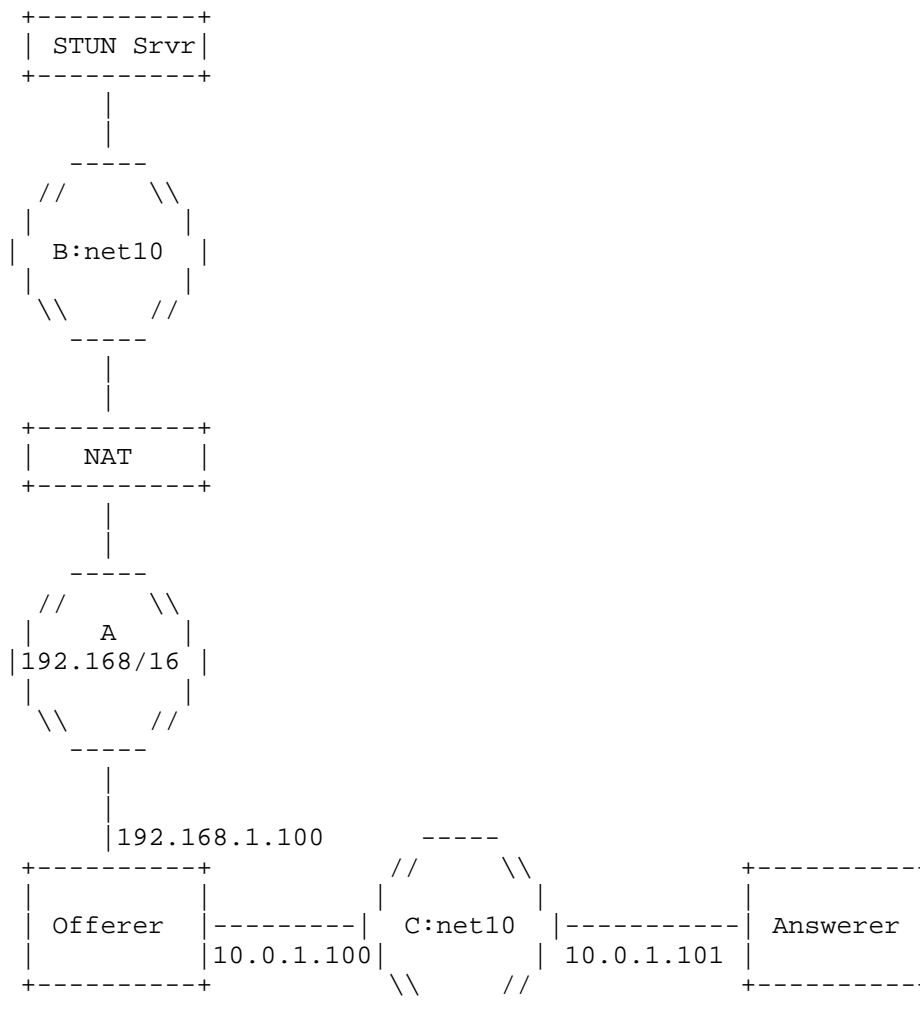

Figure 10: Identical Candidates with Different Bases

In this case, the offerer is multihomed. It has one IP address, 10.0.1.100, on network C, which is a net 10 private network. The answerer is on this same network. The offerer is also connected to network A, which is 192.168/16. The offerer has an IP address of 192.168.1.100 on this network. There is a NAT on this network, natting into network B, which is another net 10 private network, but not connected to network C. There is a STUN server on network B.

The offerer obtains a host candidate on its IP address on network C (10.0.1.100:2498) and a host candidate on its IP address on network A

(192.168.1.100:3344). It performs a STUN query to its configured STUN server from 192.168.1.100:3344. This query passes through the NAT, which happens to assign the binding 10.0.1.100:2498. The STUN server reflects this in the STUN Binding response. Now, the offerer has obtained a server reflexive candidate with a transport address that is identical to a host candidate (10.0.1.100:2498). However, the server reflexive candidate has a base of 192.168.1.100:3344, and the host candidate has a base of 10.0.1.100:2498.

### B.3. Purpose of the <rel-addr> and <rel-port> Attributes

The candidate attribute contains two values that are not used at all by ICE itself -- <rel-addr> and <rel-port>. Why is it present?

There are two motivations for its inclusion. The first is diagnostic. It is very useful to know the relationship between the different types of candidates. By including it, an agent can know which relayed candidate is associated with which reflexive candidate, which in turn is associated with a specific host candidate. When checks for one candidate succeed and not for others, this provides useful diagnostics on what is going on in the network.

The second reason has to do with off-path Quality of Service (QoS) mechanisms. When ICE is used in environments such as PacketCable 2.0, proxies will, in addition to performing normal SIP operations, inspect the SDP in SIP messages, and extract the IP address and port for media traffic. They can then interact, through policy servers, with access routers in the network, to establish guaranteed QoS for the media flows. This QoS is provided by classifying the RTP traffic based on 5-tuple, and then providing it a guaranteed rate, or marking its Diffserv codepoints appropriately. When a residential NAT is present, and a relayed candidate gets selected for media, this relayed candidate will be a transport address on an actual TURN server. That address says nothing about the actual transport address in the access router that would be used to classify packets for QoS treatment. Rather, the server reflexive candidate towards the TURN server is needed. By carrying the translation in the SDP, the proxy can use that transport address to request QoS from the access router.

### B.4. Importance of the STUN Username

ICE requires the usage of message integrity with STUN using its short-term credential functionality. The actual short-term credential is formed by exchanging username fragments in the SDP offer/answer exchange. The need for this mechanism goes beyond just security; it is actually required for correct operation of ICE in the first place.

Consider agents L, R, and Z. L and R are within private enterprise 1, which is using 10.0.0.0/8. Z is within private enterprise 2, which is also using 10.0.0.0/8. As it turns out, R and Z both have IP address 10.0.1.1. L sends an offer to Z. Z, in its answer, provides L with its host candidates. In this case, those candidates are 10.0.1.1:8866 and 10.0.1.1:8877. As it turns out, R is in a session at that same time, and is also using 10.0.1.1:8866 and 10.0.1.1:8877 as host candidates. This means that R is prepared to accept STUN messages on those ports, just as Z is. L will send a STUN request to 10.0.1.1:8866 and another to 10.0.1.1:8877. However, these do not go to Z as expected. Instead, they go to R! If R just replied to them, L would believe it has connectivity to Z, when in fact it has connectivity to a completely different user, R. To fix this, the STUN short-term credential mechanisms are used. The username fragments are sufficiently random that it is highly unlikely that R would be using the same values as Z. Consequently, R would reject the STUN request since the credentials were invalid. In essence, the STUN username fragments provide a form of transient host identifiers, bound to a particular offer/answer session.

An unfortunate consequence of the non-uniqueness of IP addresses is that, in the above example, R might not even be an ICE agent. It could be any host, and the port to which the STUN packet is directed could be any ephemeral port on that host. If there is an application listening on this socket for packets, and it is not prepared to handle malformed packets for whatever protocol is in use, the operation of that application could be affected. Fortunately, since the ports exchanged in SDP are ephemeral and usually drawn from the dynamic or registered range, the odds are good that the port is not used to run a server on host R, but rather is the agent side of some protocol. This decreases the probability of hitting an allocated port, due to the transient nature of port usage in this range. However, the possibility of a problem does exist, and network deployers should be prepared for it. Note that this is not a problem specific to ICE; stray packets can arrive at a port at any time for any type of protocol, especially ones on the public Internet. As such, this requirement is just restating a general design guideline for Internet applications -- be prepared for unknown packets on any port.



#### B.5. The Candidate Pair Priority Formula

The priority for a candidate pair has an odd form. It is:

$$\text{pair priority} = 2^{32} * \text{MIN}(G,D) + 2 * \text{MAX}(G,D) + (G > D ? 1 : 0)$$

Why is this? When the candidate pairs are sorted based on this value, the resulting sorting has the MAX/MIN property. This means that the pairs are first sorted based on decreasing value of the minimum of the two priorities. For pairs that have the same value of the minimum priority, the maximum priority is used to sort amongst them. If the max and the min priorities are the same, the controlling agent's priority is used as the tie-breaker in the last part of the expression. The factor of  $2^{32}$  is used since the priority of a single candidate is always less than  $2^{32}$ , resulting in the pair priority being a "concatenation" of the two component priorities. This creates the MAX/MIN sorting. MAX/MIN ensures that, for a particular agent, a lower-priority candidate is never used until all higher-priority candidates have been tried.

#### B.6. The remote-candidates Attribute

The a=remote-candidates attribute exists to eliminate a race condition between the updated offer and the response to the STUN Binding request that moved a candidate into the Valid list. This race condition is shown in Figure 11. On receipt of message 4, agent L adds a candidate pair to the valid list. If there was only a single media stream with a single component, agent L could now send an updated offer. However, the check from agent R has not yet generated a response, and agent R receives the updated offer (message 7) before getting the response (message 9). Thus, it does not yet know that this particular pair is valid. To eliminate this condition, the actual candidates at R that were selected by the offerer (the remote candidates) are included in the offer itself, and the answerer delays its answer until those pairs validate.

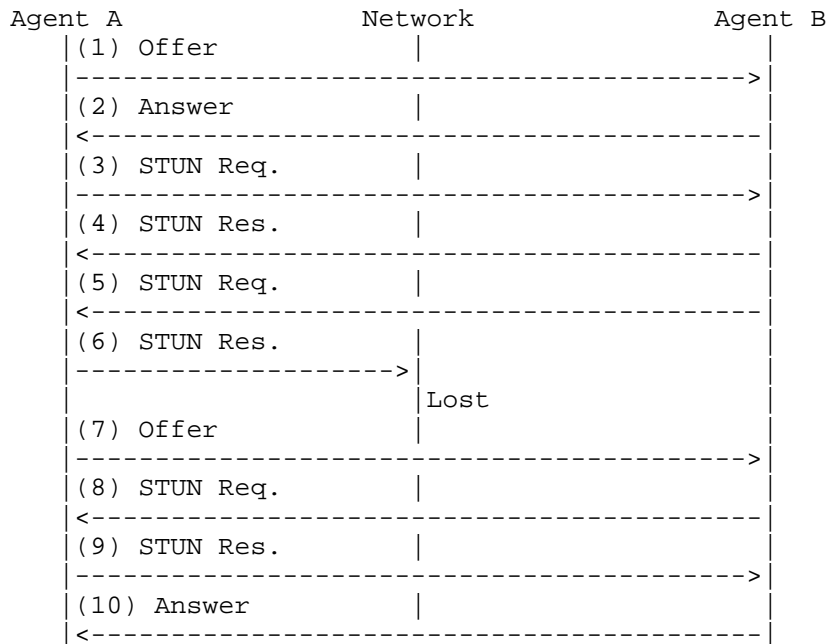

Figure 11: Race Condition Flow

B.7. Why Are Keepalives Needed?

Once media begins flowing on a candidate pair, it is still necessary to keep the bindings alive at intermediate NATs for the duration of the session. Normally, the media stream packets themselves (e.g., RTP) meet this objective. However, several cases merit further discussion. Firstly, in some RTP usages, such as SIP, the media streams can be "put on hold". This is accomplished by using the SDP "sendonly" or "inactive" attributes, as defined in RFC 3264 [RFC3264]. RFC 3264 directs implementations to cease transmission of media in these cases. However, doing so may cause NAT bindings to timeout, and media won't be able to come off hold.

Secondly, some RTP payload formats, such as the payload format for text conversation [RFC4103], may send packets so infrequently that the interval exceeds the NAT binding timeouts.

Thirdly, if silence suppression is in use, long periods of silence may cause media transmission to cease sufficiently long for NAT bindings to time out.

For these reasons, the media packets themselves cannot be relied upon. ICE defines a simple periodic keepalive utilizing STUN Binding indications. This makes its bandwidth requirements highly predictable, and thus amenable to QoS reservations.

#### B.8. Why Prefer Peer Reflexive Candidates?

Section 4.1.2 describes procedures for computing the priority of candidate based on its type and local preferences. That section requires that the type preference for peer reflexive candidates always be higher than server reflexive. Why is that? The reason has to do with the security considerations in Section 18. It is much easier for an attacker to cause an agent to use a false server reflexive candidate than it is for an attacker to cause an agent to use a false peer reflexive candidate. Consequently, attacks against address gathering with Binding requests are thwarted by ICE by preferring the peer reflexive candidates.

#### B.9. Why Send an Updated Offer?

Section 11.1 describes rules for sending media. Both agents can send media once ICE checks complete, without waiting for an updated offer. Indeed, the only purpose of the updated offer is to "correct" the SDP so that the default destination for media matches where media is being sent based on ICE procedures (which will be the highest-priority nominated candidate pair).

This begs the question -- why is the updated offer/answer exchange needed at all? Indeed, in a pure offer/answer environment, it would not be. The offerer and answerer will agree on the candidates to use through ICE, and then can begin using them. As far as the agents themselves are concerned, the updated offer/answer provides no new information. However, in practice, numerous components along the signaling path look at the SDP information. These include entities performing off-path QoS reservations, NAT traversal components such as ALGs and Session Border Controllers (SBCs), and diagnostic tools that passively monitor the network. For these tools to continue to function without change, the core property of SDP -- that the existing, pre-ICE definitions of the addresses used for media -- the m and c lines and the rtcp attribute -- must be retained. For this reason, an updated offer must be sent.

#### B.10. Why Are Binding Indications Used for Keepalives?

Media keepalives are described in Section 10. These keepalives make use of STUN when both endpoints are ICE capable. However, rather than using a Binding request transaction (which generates a response), the keepalives use an Indication. Why is that?

The primary reason has to do with network QoS mechanisms. Once media begins flowing, network elements will assume that the media stream has a fairly regular structure, making use of periodic packets at fixed intervals, with the possibility of jitter. If an agent is sending media packets, and then receives a Binding request, it would need to generate a response packet along with its media packets. This will increase the actual bandwidth requirements for the 5-tuple carrying the media packets, and introduce jitter in the delivery of those packets. Analysis has shown that this is a concern in certain layer 2 access networks that use fairly tight packet schedulers for media.

Additionally, using a Binding Indication allows integrity to be disabled, allowing for better performance. This is useful for large-scale endpoints, such as PSTN gateways and SBCs.

B.11. Why Is the Conflict Resolution Mechanism Needed?

When ICE runs between two peers, one agent acts as controlled, and the other as controlling. Rules are defined as a function of implementation type and offerer/answerer to determine who is controlling and who is controlled. However, the specification mentions that, in some cases, both sides might believe they are controlling, or both sides might believe they are controlled. How can this happen?

The condition when both agents believe they are controlled shows up in third party call control cases. Consider the following flow:

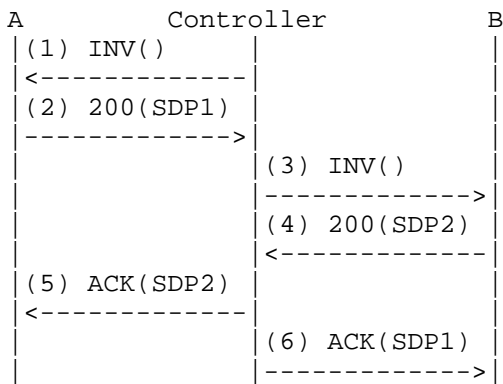

Figure 12: Role Conflict Flow

This flow is a variation on flow III of RFC 3725 [RFC3725]. In fact, it works better than flow III since it produces fewer messages. In this flow, the controller sends an offerless INVITE to agent A, which

responds with its offer, SDP1. The agent then sends an offerless INVITE to agent B, which it responds to with its offer, SDP2. The controller then uses the offer from each agent to generate the answers. When this flow is used, ICE will run between agents A and B, but both will believe they are in the controlling role. With the role conflict resolution procedures, this flow will function properly when ICE is used.

At this time, there are no documented flows that can result in the case where both agents believe they are controlled. However, the conflict resolution procedures allow for this case, should a flow arise that would fit into this category.

#### Author's Address

Jonathan Rosenberg  
jdrosen.net  
Monmouth, NJ  
US

Email: [jdrosen@jdrosen.net](mailto:jdrosen@jdrosen.net)  
URI: <http://www.jdrosen.net>